

**Attachment H –
Assumptions and Modeling Report**

Evaluation of Alternatives to Achieve Phosphorus WQBELs in Discharges to the Everglades Protection Area

prepared for

U.S. Environmental Protection Agency

By

William W. Walker, Jr., Ph.D

Environmental Engineer

Concord, Massachusetts

<http://www.wwwalker.net>

September 2, 2010

The following summarizes key assumptions and modeling results for alternative plans to achieve Water Quality Based Effluent Limits (WQBELs) for total phosphorus concentrations in discharges from Stormwater Treatment Areas (STAs) into the Everglades Protection Area. It is assumed that follow-up studies will be performed to optimize features of selected alternative(s), as well as to evaluate schedule and cost factors in order to provide a basis for selecting the final design.

- 1) The design target for STA outflow concentrations is 11.5 ppb, expressed long-term (40-year) flow-weighted mean outflow concentration (LTFWM). This target is approximately equivalent to a long-term geometric mean (LTGM) of 9.3 ppb, based upon the statistical derivation of the WQBEL. The target provides a margin of safety for achieving the P Criterion (LTGM= 10 ppb) and reducing the risk of exceeding the WQBELs.
- 2) Treatment objectives can be achieved using various combinations of (a) expanded Stormwater Treatment Areas (STAs), (b) Flow Equalization Basins (FEBs), (c) diversion of flows with relatively low P concentrations from the C51 East basin into the Refuge STAs, and (d) distribution of flows across the FEBs and STAs to optimize performance.
- 3) For purposes of design, no additional phosphorus source controls beyond those in place during 2005-2009 are assumed. Source controls, further optimization of the STA designs and operation, and other measures may be implemented by SFWMD to provide an additional margin of safety and reduce the risk of exceeding the WQBEL.
- 4) The existing treatment facilities do not include FEBs. In the scenarios evaluated, FEB maximum depths range from 8 to 44 feet, as compared with STA maximum depths of ~4 feet. Their primary functions are to improve STA performance by storing and attenuating

peak flows during wet periods and by releasing flow during dry periods to help maintain STA water levels and vegetation. FEBs provide operational flexibility for real-time regional water management (e.g. balancing flows across STAs; facilitating STA maintenance). These benefits provide an additional margin of safety that is not reflected in the model simulations. Optimization of the FEB parameters in subsequent design studies may improve performance and provide additional operational flexibility.

- 5) Average source flows, phosphorus loads, and phosphorus concentrations that provide a basis for design are listed in Table 1. The datasets have been developed jointly with SFWMD.
- 6) Flows are derived from Restoration Strategies Baseline South Florida Water Management Model (RSB2X2) daily simulation of WY 1966-2005 (May 1, 1966 – April 30, 2005) hydrologic conditions with current infrastructure.
- 7) Source concentrations are based upon monthly flow-weighted means computed from monitoring data collected between Water Years 2005-2009 (May 1, 2004 to April 30, 2009). Phosphorus concentrations in releases from Lake Okeechobee to STA-34 are based upon data collected at the lake outlet structure.
- 8) It is assumed that average STA inflow volumes, concentrations, and loads computed from 2005-2009 data and 2x2 simulated flows will not increase in the future.
- 9) To account for reductions in watershed area associated with STA or FEB construction, source flows and loads are reduced based upon the ratio of the effective treatment area of the project to the existing watershed area in the basin containing the project.
- 10) For initial planning purposes, the effective treatment area (surface area at normal operating depth) for each STA or FEB is increased by 10% to estimate the total amount of land required. This accounts for the associated infrastructure (pumps, canals, levees, roads, etc). The 10% factor will be adjusted in detailed design depending on the actual site locations and STA/FEB configuration, as long as the effective treatment area of the final project is not less than that specified in the planning scenarios.
- 11) Each scenario is designed to treat all of the flow discharged from the source basins over the 40-year simulation period (WY 1966-2005). More detailed hydraulic analyses will be needed to design the infrastructure and operations needed to guarantee that there will be no untreated bypasses around the STAS into the Everglades under hydrologic conditions that are reflected in the 40-year simulation period. Infrastructure and operational plans will be provided to divert infrequent extreme event flows that exceed STA treatment capacity to the coast or other locations outside of the Everglades Protection Area.
- 12) None of the WQBEL scenarios rely on future construction or operation of projects that are outside of the scope of those specified in the scenarios (e.g. CERP or other restoration projects).

- 13) The selected alternative will not decrease the average inflow to Loxahatchee Refuge or adversely impact water levels, as evaluated with the Refuge water balance model (SRSM) and its associated performance measures. Preliminary analyses indicate that each of the scenarios meets the Refuge water needs according to these criteria. This will be confirmed before selecting a final alternative in the subsequent design phase.
- 14) The Dynamic Model for Stormwater Treatment Areas (DMSTA, Walker & Kadlec, 2005, <http://www.wwwalker.net/dmsta>) is used to simulate the hydraulics and phosphorus removal performance of the FEBs and STAs. DMSTA was developed explicitly for this purpose and calibrated to extensive monitoring data from the STAs, test cells, and other treatment wetlands. The model has been used in several feasibility and detailed design studies performed by SFWMD and its contractors over the 2001-2010 period. Despite inherent modeling uncertainties and limitations, the SFWMD, state, and federal agencies have agreed that this is the best available tool for use in design. Summary of model input values is provided in Table 2.
- 15) Modeling uncertainty is estimated at $\pm 15\%$ of the predicted LTFWM for each STA. The total forecast uncertainty is likely to be greater because of variability in future climatologic conditions and uncertainty in the assumed source flows and phosphorus loads. In addition to the margin of safety inherent in the specified design target (equivalent to a LTGM = 9.3 vs. 10 ppb), additional measures can be taken to account for performance uncertainty and reduce risk of exceeding the WQBEL (e.g., source controls, further STA optimization, research and monitoring to improve treatment technology).
- 16) The scenarios (Table 3) include four basic alternatives (A, B, C, D) involving different combinations of expanded STAs, FEBs, and diversion of additional flow into the Everglades from the C51 East Basin. Each scenario is simulated with a final configuration (full-scale operation) and interim configuration (partial construction, accelerated to achieve WQBEL in STA34 and improve performance of the other STAs). For comparison purposes, the scenarios also include the existing STAs with and without Compartments B & C in operation.
- 17) Table 4 summarizes the water and phosphorus balances for each STA and scenario. WQBEL excursion frequencies are calculated from the yearly outflow FWM time series for each STA. Based upon WQBEL derivation results, the yearly FWM is divided by 1.23 to estimate the outflow geometric mean. Under full operation (Scenarios A, B, C, D), the predicted number of excursion events over the 40 year record ranges from 0 to 3. The results do not account for the inherent uncertainty in climate, source datasets, STA vegetation management, and modeling. Implementing source controls and additional measures not assumed in the design calculations will provide a margin of safety and reduce the risk of exceeding the WQBEL in the context of the uncertainties associated with forecasting project performance.

18) The STA/FEB expansion requirements and outflows to the EPA and Lake Worth for each alternative under full operation are summarized below. The total area requirements vary over a relatively narrow range (41-44 kac). The C51E Diversion/FEB scenarios (C & D) provide significant increase in total flow to the Everglades without substantially increasing the total area requirements relative to Scenarios A & B.

Full Operation Scenario	New Inflow	New Effective Area kac			Total kac	Outflow kaf/yr	
		STA	FEB	Total		To Ever	Estuary
A - East & Cent STA	-	30.6	7.0	37.6	41.4	1416	273
B - East STA, Cent FEB	-	28.5	10.0	38.5	42.4	1408	203
C - C51 FEB, Cent STA	C51E	30.0	8.7	38.7	42.5	1584	16
D - C51 FEB, Cent FEB	C51E	27.0	12.7	39.7	43.6	1574	16

Table 1- Source Flows & Phosphorus Loads (Prior to STA Expansion) *

Source	Flow kac-ft/yr	Load mt/yr	Conc ppb
S5A Runoff to WPB	235.4	53.0	182
298 - EBWCD	24.2	14.7	492
S361 Runoff to STA1E	9.7	0.9	73
C51 West + ACME	159.7	32.2	163
L8 Runoff to C51W Canal	25.0	4.2	135
S352 Urban Water Supply	2.3	0.3	103
Total STA-1W+1E	456.3	105.2	187
S5A Runoff to STA2	61.0	16.0	213
S6 Runoff to STA2	181.2	27.8	124
ESWCD & 715 to Hills	31.0	6.3	165
Total STA-2 + Comp B	273.2	50.2	149
S7 Runoff to STA34	121.5	18.1	121
S7 Runoff to Comp B (redirected)	142.2	21.0	120
S8 Runoff to STA34	219.4	28.3	104
298 - SSD	5.2	0.7	112
298 - SFCD	19.1	2.6	112
298 - SSDD	6.9	1.2	139
C139_G136 to STA34	11.7	3.0	209
S354 Lake Urban WS	19.6	3.7	153
S351 Lake Urban WS	6.8	1.5	178
S354 Lake Reg Release	58.5	12.4	172
Total STA-34	611.0	92.5	123
C139 South Runoff	176.6	50.1	230
C139 North Runoff (L1/G136)	2.4	0.7	234
C139 Annex	21.3	2.6	97
STA6 Water Supply	6.8	1.4	171
Total STA 5-6	207.1	54.8	214
Total All Basins	1547.6	302.7	158
C51E Diversion Option			
Total C51E Runoff	202.6	23.9	96
C51E Diverted to STA1W/E	187.1	22.1	96
C51E Discharged to Estuary	15.6	1.9	96

* Assumptions and data developed jointly with SFWMD.

Table 2 – Summary of DMSTA Modeling Assumptions

Parameter	Comments
General	Except where noted, DMSTA parameters for the existing STA cells are derived from the values assumed in the September 2009 update of the Long-Term Plan and/or updates specified in SFWMD simulations of WQBEL scenarios. Detailed model parameters are specified in the DMSTA input file for each scenario.
Simulation Dates	Start Date: 1/1/1965 (SFWMM Output); Output Dates: 5/1/1965-4/30/2005 (Water Years 1966-2005)
Number of Iterations	1 iteration. The initial P storage in each cell is initialized at the average value predicted from the previous model run; this enables simulation with 1 iteration provided that the each scenario is simulated at least twice in the course of the design process.
Atmospheric Deposition	Assumed in DMSTA calibration and previous design studies. Dry deposition 20 mg/m ² -yr; Rainfall P Concentration = 10 ppb.
Duty Cycle Factor	<p>Duty Cycle = 0.95 for STAs; refers to the portion of time that an STA is offline for major maintenance or rehabilitation activities. A value of 0.95 is meant to correspond to an STA being offline 5% of the time (1 year out of every 20 years). This assumption is consistent with historical STA operations after startup periods.</p> <p>Duty Cycle = 1.0 for FEBs; minimal vegetation management</p>
DMSTA Vegetation Types	<p>EMG: Emergent or unmanaged vegetation on previously farmed or disturbed soils</p> <p>SAV: Cells managed to promote submersed aquatic vegetation (SAV); generally deeper than emergent cells</p> <p>PSTA: Periphyton treatment area on limerock/shellrock substrate</p> <p>PEW: Pre-Existent Wetland; emergent or unmanaged veg. on previous wetland or undisturbed soils</p> <p>RES: Deep (8-44 ft); open water; dominated by algae and floating vegetation, as opposed to emergent or submersed vegetation.</p> <p>Current STAs contain various combinations of emergent and SAV. STA-2 cell 2 is modeled using the PEW calibration (existing).</p> <p>The EMG/SAV split for new cells in the eastern & central basins is 33/67, typical of the existing STAs.</p>

	<p>The EMG/PEW split for new cells in the western basin is 60/40. Downstream cells in each flow path of the existing and expanded STAs in the western basin are modeled using the PEW calibration. Maintenance of SAV in the western basin has proven to be difficult because of high seepage rates, frequent dry-out, and low calcium levels in the basin runoff.</p> <p>The RES calibration is used for FEBs.</p> <p>None of the cells are modeled with the PSTA calibration, although conversion to periphyton communities may be a future management option.</p>
Inflow Fraction	Total cell area in each flow path / total STA area; balances hydraulic loads across flow paths within each STA
Mean Width of Flow Path	As constructed for existing cells. The width of new flow paths is computed from area assuming a 3/1 length to width ratio along each EMG/SAV flow path. A length/width ratio of 1.0 is assumed to FEBs. Performance is insensitive to width assumptions.
Number of Tanks in Series	A TIS value of 1 is used for FEBs. Consistent with previous design assumptions, a TIS value of 3 is used in each new STA cell. This assumes that the cell will be constructed and managed to provide relatively even ground surface and flow distribution across the width of each flow path (minimal short-circuiting) and contain at least one internal levee to separate the emergent and SAV communities.
FEB Release Series	Release to STAs to help maintain water levels in droughts. Computed based upon 30-day antecedent average ET – Rainfall multiplied by the downstream STA area. If ET exceeds rainfall, a proportionate release is made; potential release from C51 FEB for urban water supply; release for maintenance of Refuge stage (minimum total inflow to STA1E+W from all sources = 500 cfs for June-October; not optimized). Minimum drawdown depth = 0.5 ft.
FEB Depth Series	Monthly regulation schedule specified for FEBs. Range from 0% in wet season (to capture storms) to 80% of capacity in dry season (stores water for use in STA irrigation, urban water supply); To be optimized in final design.
FEB Outflow Hydraulic Coefficients	Slope = 1; intercept varied to provide specified mean hydraulic residence time in the FEB (90 days in western FEB, 60 days in central FEB, 30 days in FEB). Values adjusted based upon simulated water levels, flow capture, and flow attenuation; to be optimized in final design.
STA Outflow Control Depth	~1.25 ft. No outflow below this level; typical of existing STA cells
STA Outflow Hydraulic Coefficients	Slope = 4, Intercept = 1; typical values calibrated to existing STA cells

STA Bypass Triggers	Each STA is assumed to treat all of the simulated flow without bypass. Simulated water levels and inflow volumes are generally consistent with that assumption, but will be confirmed in detailed design, which will provide suitable infrastructure to avoid untreated bypass.
FEB Bypass Triggers	Maximum depth varies with design (12 ft for West, 8 ft for Central, 44 ft for Eastern FEB (C51E Project Design)); Maximum inflows (2500, 3000, and 2000 cfs, respectively); to be optimized in final designs.
Seepage Rates	Generally consistent with seepage rates assumed in previous simulations of the existing STAs (.005 – 0.2 cm/d/cm) ; seepage rates in STA-34 are reduced by 75% relative to SFWMD simulations to be more consistent with the observed overall water budget of STA-34. No seepage losses assumed for FEBs; seepage rates to be considered in final design (could be released to STAs or recycled to FEB).
Seepage Recycling	No seepage recycling is included in the simulations. This is conservative with respect to maintaining STA water levels. Any seepage recycling in new cells would depend on cell location and configuration relative to existing cells. Seepage collection and recycling will be optimized in detailed designs.

Table 3 – Scenario Definitions and Results

All Scenarios: Long-Term Flow-Weighted-Mean Design Target = 11.5 ppb (equivalent to LT Geometric Mean ~ 9.3 ppb), 2005-2009 Source TP Concentrations

ID	Label	Description	Inflow Conc ppb			STA Expan. (Effective)*				FEB Effective Area				FEB Vol.		FEB+STA		Outflow FWM ppb ***					Outflows kac-ft/yr			
			West	Cent	East	West	Cent	East	Total	West	Cent	East	Total	kac-ft	Effect	Total	West	34	2+B	East	Total	WCA1	2A+3A	Total	Estuary	
1	Current **	Current System without Comp B & C	214	131	187	8.9	24.8	11.8	45.5						45.5	50.0	29.7	25.5	33.2	34.6	30.1	448	1050	1497	273	
2	Current + Comp B & C **	Current System with Comp B & C	214	131	187	13.0	31.7	11.8	56.5						56.5	62.1	18.3	15.7	20.3	34.1	23.0	448	1042	1490	203	
3	A - East & Cent STA	STA Expansion in East & Central; 12-ft FEB in West	219	131	187		15.6	15.0	30.6	7.0		7.0	84	37.6	41.4	11.4	11.5	11.5	11.4	11.5	429	987	1416	273		
4	B - East STA, Cent FEB	8-ft FEB in Comp A2, STA in Comp A1; 12-ft FEB in West; STA expansion in East	219	131	187		13.5	15.0	28.5	7.0	3.0	10.0	108	38.5	42.4	11.5	11.3	11.3	11.4	11.4	429	979	1408	203		
5	A/B-Interim (4 yrs)	Interim Plan for Scenarios 3 or 4; A1 Operated as 4 ft FEB; balance flows to achieve WQBEL in STA34; Meanwhile construct A2 8-ft FEB (or STA), Convert A1 FEB to STA, expand STA1W; 12-ft FEB in West	214	132	188						15.0	15.0	60	15.0	16.5	18.3	11.2	18.2	31.9	20.4	448	975	1397	228		
6	C - C51 FEB, Cent STA	C51E Diversion & 44-ft Rockpit / FEB + STA Expansion in East & Central; 12-ft FEB in West	219	131	160		22.0	8.0	30.0	7.0	1.7	8.7	157	38.7	42.5	11.1	11.5	11.5	11.5	11.5	444	1140	1584	16		
7	D - C51 FEB, Cent FEB	C51E Diversion & Rockpit/FEB in East; 8-ft FEB, STA Exp in A1 & A2, 12-ft FEB in West	219	132	160		19.0	8.0	27.0	7.0	4.0	1.7	12.7	189	39.7	43.6	11.5	11.5	11.5	11.5	11.5	444	1130	1574	16	
8	C/D - Interim (4 Yrs)	Interim Plan for Scenarios 6 or 7; C51E rockpit partially complete (6 ft vs. 44 ft final); divert L8 flows to coast; some SSA to west; no C51E diversion; A1 Operated as 4 ft FEB; achieve WQBEL in STA34; Meanwhile construct other project components (FEB in Comp A2, Complete C51 Rockpit, STA1W Expansion)	214	132	188						15.0	1.7	16.7	70	16.7	18.4	18.3	11.3	19.2	30.4	20.0	389	1004	1393	226	

* Preliminary Designs Subject to More Detailed Analysis and Optimization. Approximate Model Uncertainty +/- 15% of Predicted Outflow Concentrations.

** Existing & Planned STA Effective Areas listed for Scenarios 1 & 2; STA Expansion areas listed for other scenarios; West = STA-5, STA-6, Comp C; Central = STA-34, Comp B, STA-2; East = STA-1W & STA-1E.

*** **Bold Fonts Indicate STA's Not Achieving 11.5 ppb LTFWM Target (Existing Conditions or Interim Plans)**

Table 4 - STA Mass Balances & Performance

Scenario 1		Existing STAs															
STA	Effect Area kac	STA Inflows			STA Outflows			30-Day Hydraulic Load			Depth Freq < 10 cm	Settling Rate m/yr	FEB Area kac	Depth ft	WQBEL Excursions / 40 Yrs		
		Flow kac-ft	Load mt	Conc ppb	Flow kac-ft	Load mt	Conc ppb	Mean cm/d	Max cm/d	CV -					Yearly FWM > 18	>2 Yrs GM > 10	Both Tests
STA1E	5.1	194	37.3	155	185	6.5	28.2	3.2	20.1	0.88	0%	26			29	35	37
STA1W	6.7	262	68.0	210	263	12.7	39.1	3.3	20.6	1.02	0%	26			40	38	40
STA2B	8.2	273	50.2	149	275	11.3	33.2	2.8	14.0	0.98	0%	20			40	38	40
STA34	16.5	611	92.6	123	601	18.9	25.5	3.1	13.1	0.85	1%	23			37	38	40
STA5	6.1	143	37.8	214	125	4.8	30.9	2.0	8.9	0.96	1%	18			40	38	40
STA6	2.8	64	17.0	214	48	1.6	26.5	1.9	8.7	0.96	7%	20			39	38	40
Total	45.5	1548	302.7	158	1497	55.7	30.1										

Scenario 2		Existing STAs + Compartments B & C															
STA	Effect Area kac	STA Inflows			STA Outflows			30-Day Hydraulic Load			Depth Freq < 10 cm	Settling Rate m/yr	FEB Area kac	Depth ft	WQBEL Excursions / 40 Yrs		
		Flow kac-ft	Load mt	Conc ppb	Flow kac-ft	Load mt	Conc ppb	Mean cm/d	Max cm/d	CV -					Yearly FWM > 18	>2 Yrs GM > 10	Both Tests
STA1E	5.1	221	44.1	162	211	8.8	34.0	3.6	20.8	0.86	0%	26			38	38	40
STA1W	6.7	236	61.2	210	237	10.0	34.1	2.9	18.6	1.02	0%	26			40	38	40
STA2B	15.1	474	79.9	137	478	12.0	20.3	2.6	13.0	0.99	0%	25			25	38	40
STA34	16.5	410	62.8	124	401	7.8	15.7	2.1	8.5	0.82	1%	23			5	23	24
STA5	7.9	126	33.4	214	106	2.4	18.3	1.3	6.1	0.96	2%	17			18	34	35
STA6	5.1	81	21.4	214	57	1.3	18.3	1.3	6.0	0.96	8%	17			16	34	35
Total	56.5	1548	302.7	158	1490	42.3	23.0										

Scenario 3		A- STA Expansion															
STA	Effect Area kac	STA Inflows			STA Outflows			30-Day Hydraulic Load			Depth Freq < 10 cm	Settling Rate m/yr	FEB Area kac	Depth ft	WQBEL Excursions / 40 Yrs		
		Flow kac-ft	Load mt	Conc ppb	Flow kac-ft	Load mt	Conc ppb	Mean cm/d	Max cm/d	CV -					Yearly FWM > 18	>2 Yrs GM > 10	Both Tests
STA1E	5.1	109	20.4	152	102	1.5	11.6	1.8	7.1	0.75	0%	26			0	2	2
STA1W	21.7	321	78.9	199	327	4.6	11.3	1.2	7.0	0.95	0%	21			2	0	2
STA2B	15.1	248	46.1	151	253	3.6	11.5	1.4	6.9	0.98	0%	20			0	0	0
STA34	32.1	602	91.6	123	583	8.3	11.5	1.6	6.6	0.85	1%	21			0	1	1
STA5	7.9	122	24.3	161	101	1.4	11.4	1.3	3.7	0.61	0%	20	7.0	12	0	3	3
STA6	5.1	78	15.5	161	50	0.7	11.5	1.3	3.7	0.61	2%	19			0	2	2
Total	87.1	1479	276.7	152	1416	20.0	11.5										

Scenario 4		B- STA Expansion with A2 FEB															
STA	Effect Area kac	STA Inflows			STA Outflows			30-Day Hydraulic Load			Depth Freq < 10 cm	Settling Rate m/yr	FEB Area kac	Depth ft	WQBEL Excursions / 40 Yrs		
		Flow kac-ft	Load mt	Conc ppb	Flow kac-ft	Load mt	Conc ppb	Mean cm/d	Max cm/d	CV -					Yearly FWM > 18	>2 Yrs GM > 10	Both Tests
STA1E	5.1	107	20.1	152	100	1.4	11.4	1.7	7.1	0.75	0%	26			0	1	1
STA1W	21.7	322	79.2	199	328	4.6	11.4	1.2	7.0	0.95	0%	21			2	0	2
STA2B	15.1	252	46.8	150	258	3.6	11.3	1.4	7.0	0.98	0%	21			0	0	0
STA34	30.0	589	85.5	118	570	8.0	11.3	1.6	7.0	0.81	0%	22	3.0	8	0	0	0
STA5	7.9	122	24.3	162	101	1.4	11.4	1.3	3.7	0.61	0%	20	7.0	12	0	3	3
STA6	5.1	78	15.5	162	50	0.7	11.5	1.3	3.7	0.61	2%	19			0	2	2
Total	85.0	1470	271.3	149	1408	19.7	11.4										

Table 4 - STA Mass Balances & Performance (ct.)

Scenario 5 A/B - Interim Plan without C51E Div/FEB																	
STA	Effect Area kac	STA Inflows			STA Outflows			30-Day Hydraulic Load			Depth Freq < 10 cm	Settling Rate m/yr	FEB Area kac	Depth ft	WQBEL Excursions / 40 Yrs		
		Flow kac-ft	Load mt	Conc ppb	Flow kac-ft	Load mt	Conc ppb	Mean cm/d	Max cm/d	CV -					Yearly FWM > 18	>2 Yrs GM > 10	Both Tests
STA1E	5.1	161	32.2	162	152	3.8	20.5	2.6	9.7	0.74	0%	28			20	35	36
STA1W	6.7	270	68.0	204	270	12.8	38.3	3.4	20.6	0.99	0%	27			40	38	40
STA2B	15.1	425	72.6	139	429	9.6	18.2	2.3	11.7	0.98	0%	25			16	35	37
STA34	16.5	393	47.6	98	383	5.3	11.2	2.0	8.8	0.77	1%	24	15.0	4	0	1	1
STA5	7.9	126	33.4	214	106	2.4	18.3	1.3	6.1	0.96	2%	17			18	34	35
STA6	5.1	81	21.4	214	57	1.3	18.3	1.3	6.0	0.96	8%	17			16	34	35
Total	56.5	1455	275.2	153	1397	35.2	20.4										

Scenario 6 C - C51E Div/FEB, STA Expan																	
STA	Effect Area kac	STA Inflows			STA Outflows			30-Day Hydraulic Load			Depth Freq < 10 cm	Settling Rate m/yr	FEB Area kac	Depth ft	WQBEL Excursions / 40 Yrs		
		Flow kac-ft	Load mt	Conc ppb	Flow kac-ft	Load mt	Conc ppb	Mean cm/d	Max cm/d	CV -					Yearly FWM > 18	>2 Yrs GM > 10	Both Tests
STA1E	5.1	123	18.7	123	116	1.6	11.5	2.0	7.0	0.70	0%	27	1.7	44	0	1	1
STA1W	14.7	327	63.2	157	328	4.7	11.5	1.9	8.6	0.57	0%	28			1	0	1
STA2B	15.1	291	64.0	178	296	4.2	11.5	1.6	7.0	0.97	0%	26			0	1	1
STA34	38.5	718	110.3	125	693	9.8	11.5	1.6	6.8	0.87	1%	21			0	1	1
STA5	7.9	122	24.2	161	101	1.4	11.4	1.3	3.8	0.61	0%	20	7.0	12	0	3	3
STA6	5.1	78	15.5	161	50	0.7	11.5	1.3	3.7	0.61	2%	19			0	2	2
Total	86.5	1659	296.0	145	1584	22.5	11.5										

Scenario 7 D -C51E Div/FEB, A2 FEB/ STA																	
STA	Effect Area kac	STA Inflows			STA Outflows			30-Day Hydraulic Load			Depth Freq < 10 cm	Settling Rate m/yr	FEB Area kac	Depth ft	WQBEL Excursions / 40 Yrs		
		Flow kac-ft	Load mt	Conc ppb	Flow kac-ft	Load mt	Conc ppb	Mean cm/d	Max cm/d	CV -					Yearly FWM > 18	>2 Yrs GM > 10	Both Tests
STA1E	5.1	123	18.7	123	116	1.6	11.5	2.0	7.0	0.70	0%	27	1.7	44	0	1	1
STA1W	14.7	327	63.2	157	328	4.7	11.5	1.9	8.6	0.57	0%	28			1	0	1
STA2B	15.1	291	64.0	178	296	4.2	11.5	1.6	7.0	0.97	0%	26			0	1	1
STA34	35.5	706	103.1	118	683	9.7	11.5	1.7	7.4	0.83	0%	22	4.0	8	0	2	2
STA5	7.9	122	24.3	162	101	1.4	11.4	1.3	3.7	0.61	0%	20	7.0	12	0	3	3
STA6	5.1	78	15.5	162	50	0.7	11.5	1.3	3.7	0.61	2%	19			0	2	2
Total	83.5	1647	288.8	142	1574	22.4	11.5										

Scenario 8 C/D - Interim Plan with C51E Div/FEB																	
STA	Effect Area kac	STA Inflows			STA Outflows			30-Day Hydraulic Load			Depth Freq < 10 cm	Settling Rate m/yr	FEB Area kac	Depth ft	WQBEL Excursions / 40 Yrs		
		Flow kac-ft	Load mt	Conc ppb	Flow kac-ft	Load mt	Conc ppb	Mean cm/d	Max cm/d	CV -					Yearly FWM > 18	>2 Yrs GM > 10	Both Tests
STA1E	5.1	117	21.9	152	110	1.7	12.9	1.9	8.1	0.77	0%	26	1.7	6	2	3	5
STA1W	6.7	281	66.0	190	279	12.8	37.3	3.5	21.6	0.95	0%	27			40	38	40
STA2B	15.1	453	78.7	141	458	10.9	19.2	2.5	12.3	0.98	0%	25			22	35	39
STA34	16.5	393	47.8	98	384	5.3	11.3	2.0	8.8	0.77	1%	24	15.0	4	0	2	2
STA5	7.9	126	33.4	214	106	2.4	18.3	1.3	6.1	0.96	2%	17			18	34	35
STA6	5.1	81	21.4	214	57	1.3	18.3	1.3	6.0	0.96	8%	17			16	34	35
Total	56.5	1451	269.1	150	1393	34.4	20.0										

Evaluation of Alternatives to Achieve Phosphorus WQBELs
in Discharges to the Everglades Protection Area

prepared for

U.S. Environmental Protection Agency

By

William W. Walker, Jr., Ph.D

Environmental Engineer

Concord, Massachusetts

<http://www.wwwalker.net>

Sept 2, 2010

Attachment 1 : Yearly Flow-Weighted Mean Time Series for Each Scenario

Scenario 1 Existing STAs

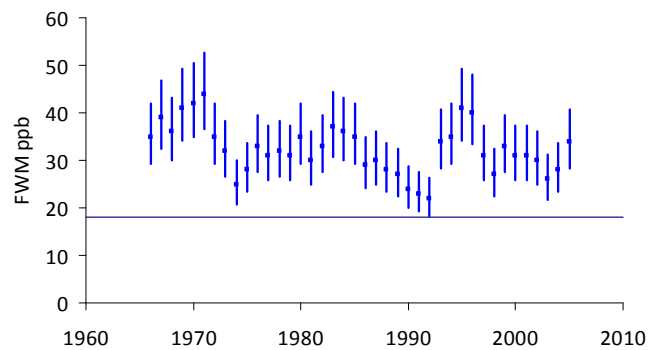
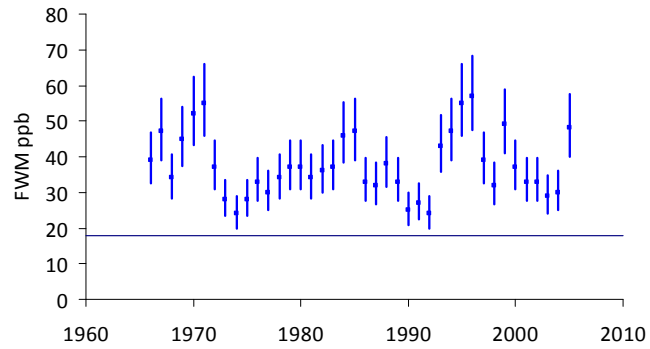
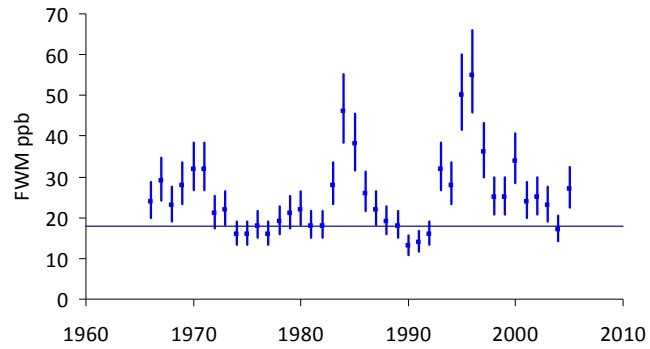

80% Confidence Intervals for Yearly Flow-Weighted Means

STA1E
 FWM
 18 ppb

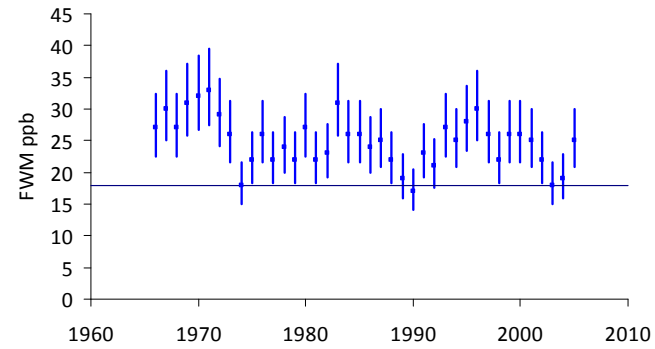

STA34
 FWM
 18 ppb

STA1W
 FWM
 18 ppb

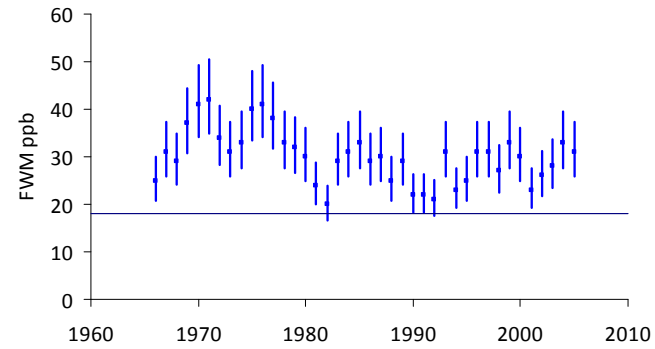

STA5
 FWM
 18 ppb

STA2B
 FWM
 18 ppb

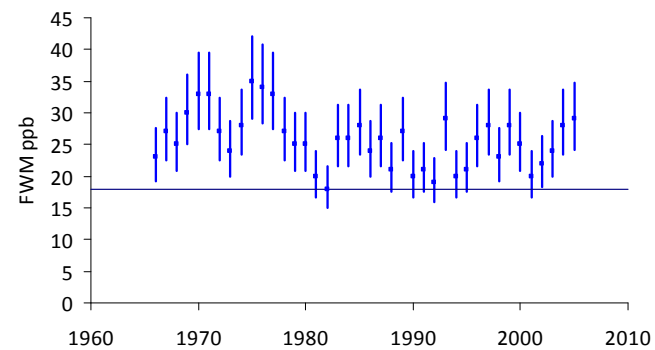

STA6
 FWM
 18 ppb

Model Predictions +/- 20%; Rounded to nearest ppb. Solid Line = 18 ppb WQBEL.

Scenario 2 Existing STAs + Compartments B & C

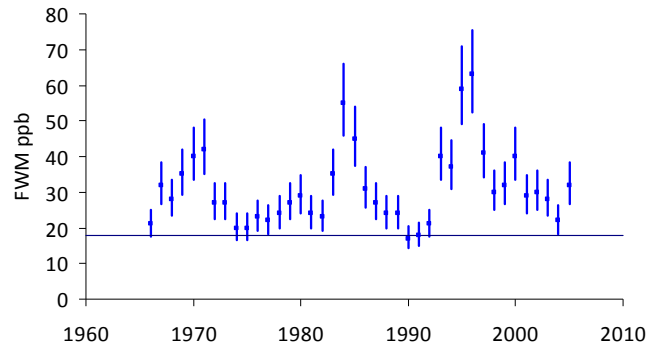

STA1E

• FWM
— 18 ppb

80% Confidence Intervals for Yearly Flow-Weighted Means

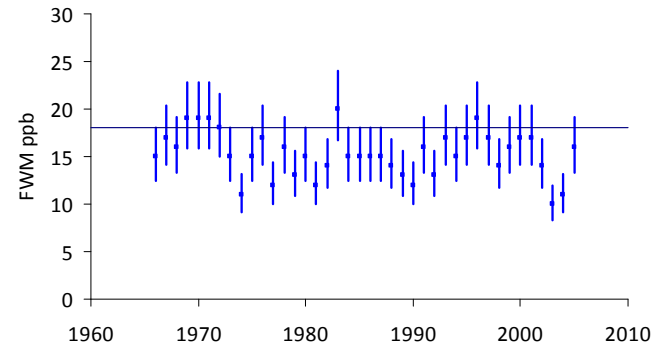

STA34

• FWM
— 18 ppb

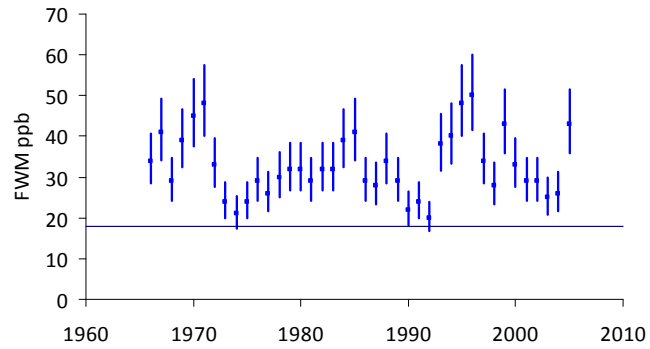

STA1W

• FWM
— 18 ppb

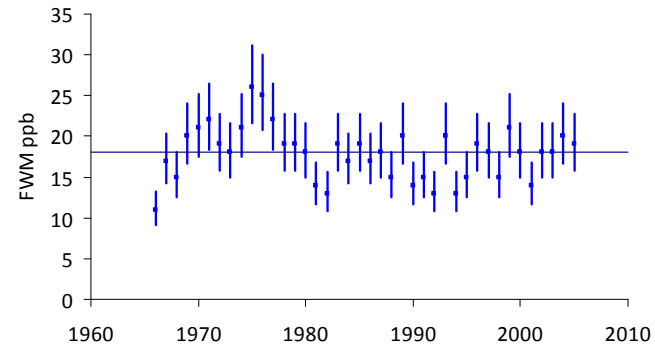

STA5

• FWM
— 18 ppb

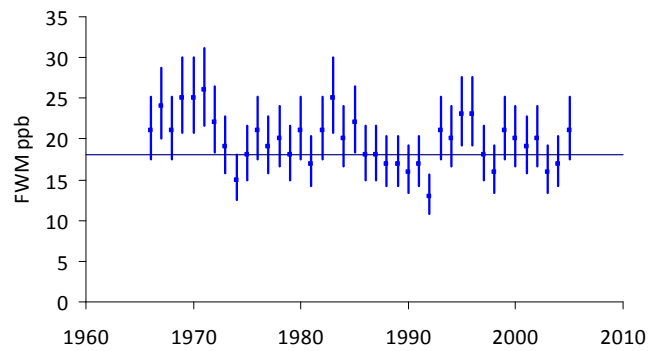

STA2B

• FWM
— 18 ppb

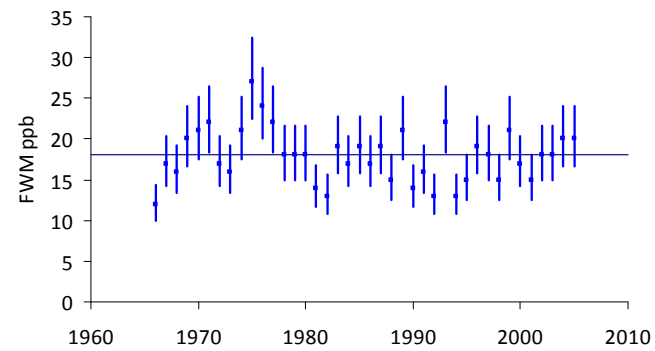

STA6

• FWM
— 18 ppb

Model Predictions +/- 20%; Rounded to nearest ppb. Solid Line = 18 ppb WQBEL.

Scenario 3 A- STA Expansion

80% Confidence Intervals for Yearly Flow-Weighted Means

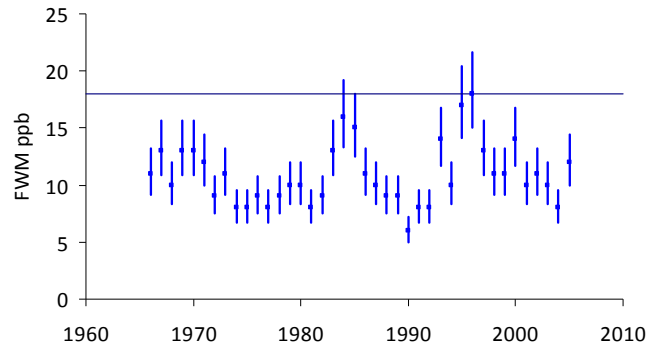

STA1E

■ FWM
— 18 ppb

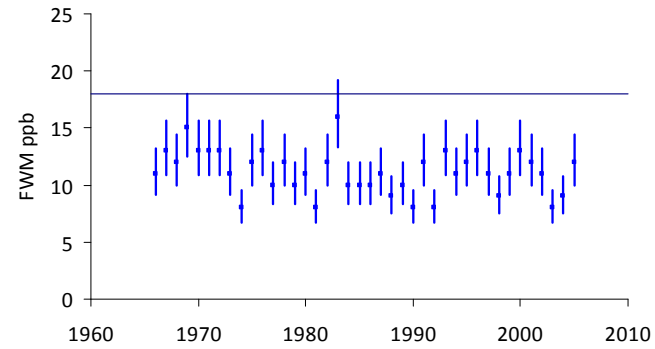

STA34

■ FWM
— 18 ppb

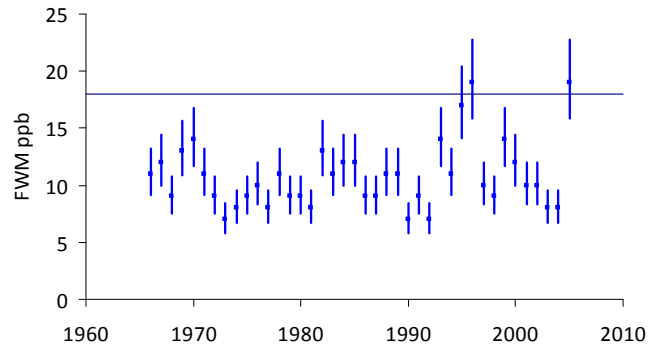

STA1W

■ FWM
— 18 ppb

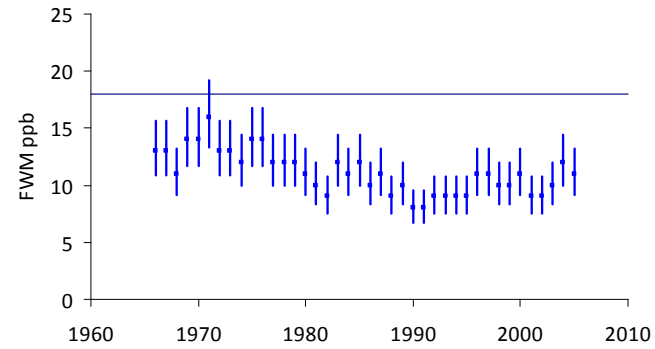

STA5

■ FWM
— 18 ppb

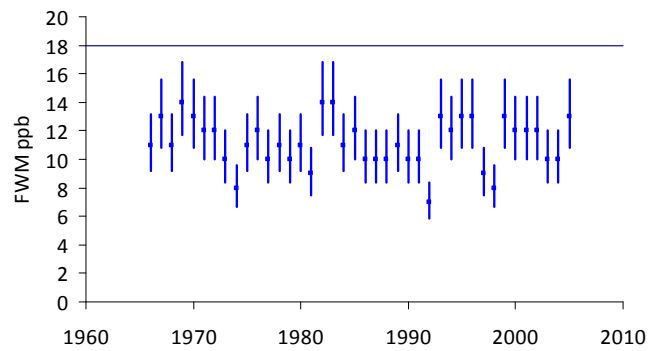

STA2B

■ FWM
— 18 ppb

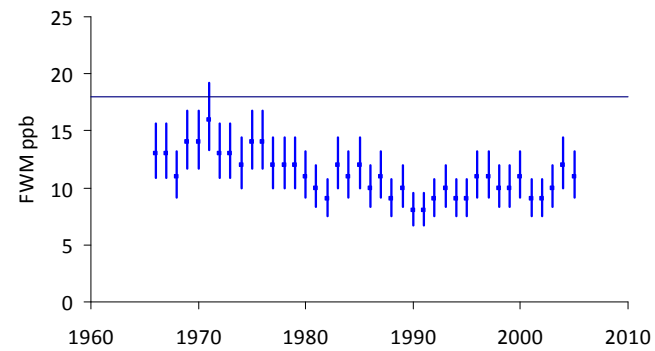

STA6

■ FWM
— 18 ppb

Model Predictions +/- 20%; Rounded to nearest ppb. Solid Line = 18 ppb WQBEL.

Scenario 4 B- STA Expansion with A2 FEB

80% Confidence Intervals for Yearly Flow-Weighted Means

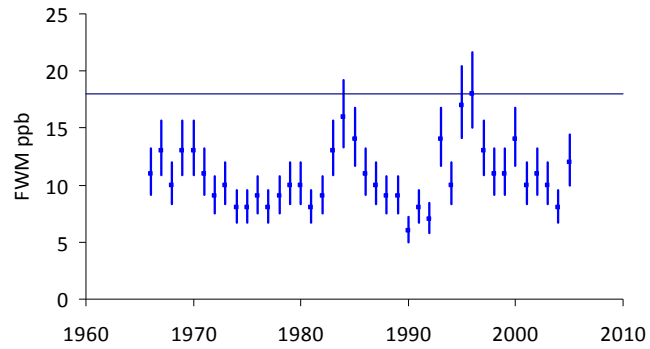

STA1E
 ■ FWM
 — 18 ppb

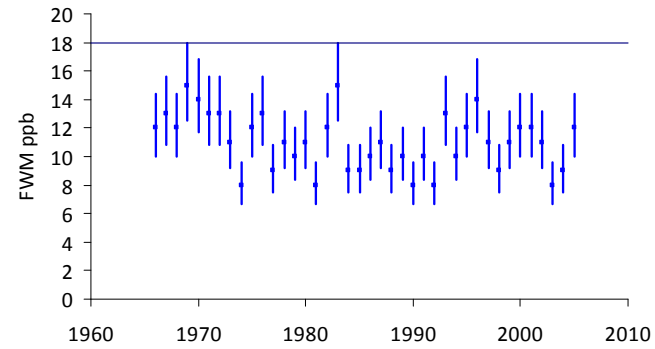

STA34
 ■ FWM
 — 18 ppb

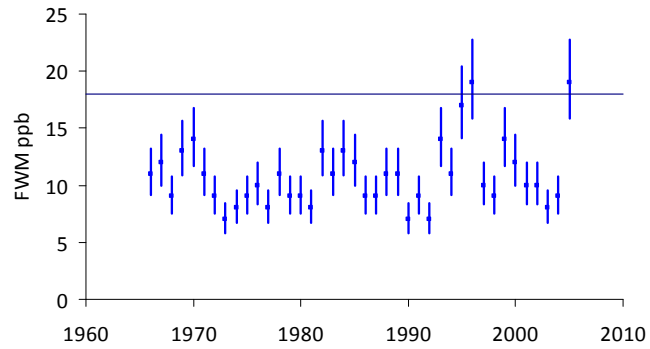

STA1W
 ■ FWM
 — 18 ppb

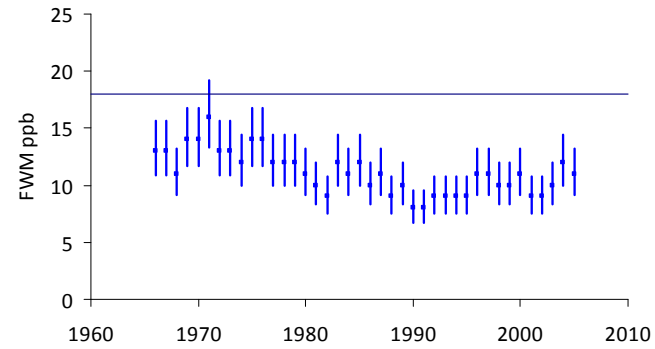

STA5
 ■ FWM
 — 18 ppb

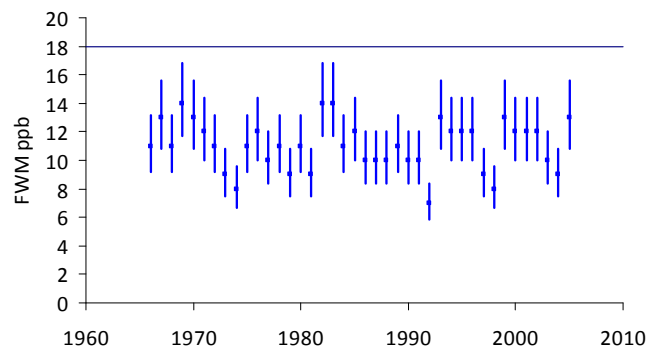

STA2B
 ■ FWM
 — 18 ppb

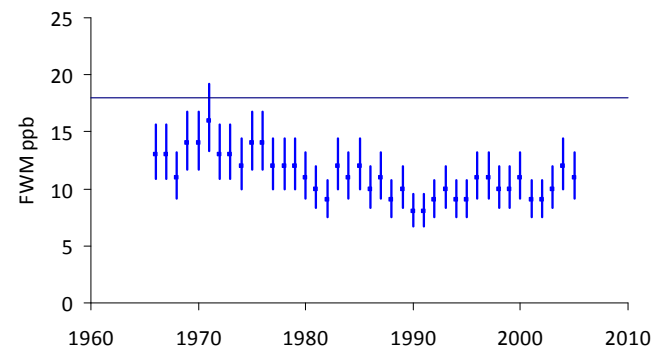

STA6
 ■ FWM
 — 18 ppb

Model Predictions +/- 20%; Rounded to nearest ppb. Solid Line = 18 ppb WQBEL.

Scenario 5 A/B - Interim Plan without C51E Div/FEB

80% Confidence Intervals for Yearly Flow-Weighted Means

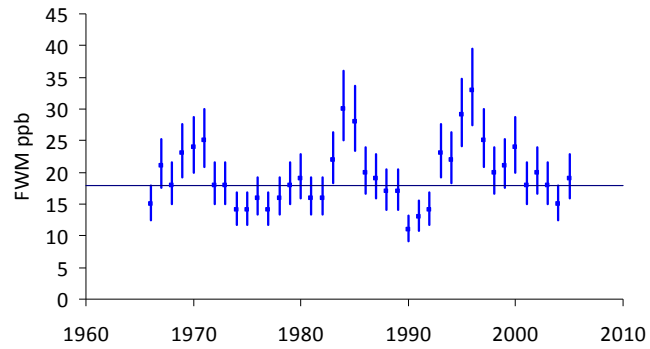

STA1E
 ■ FWM
 — 18 ppb

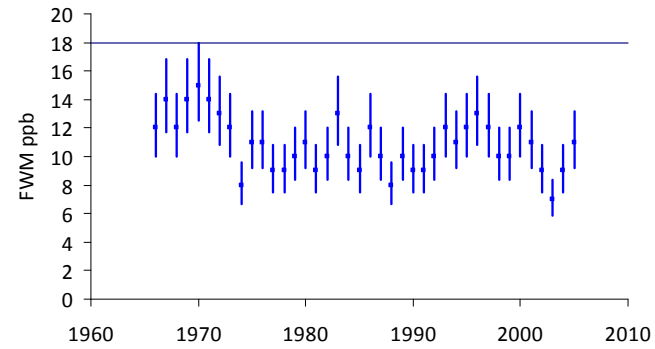

STA34
 ■ FWM
 — 18 ppb

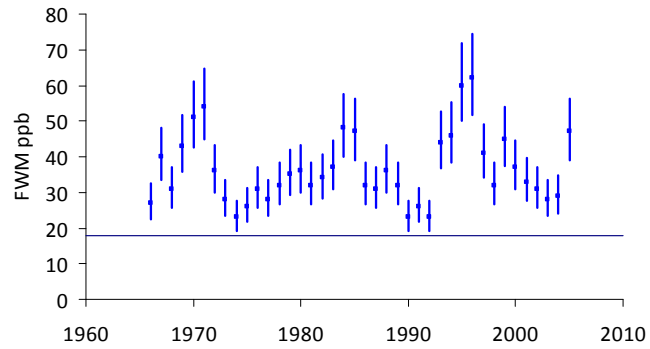

STA1W
 ■ FWM
 — 18 ppb

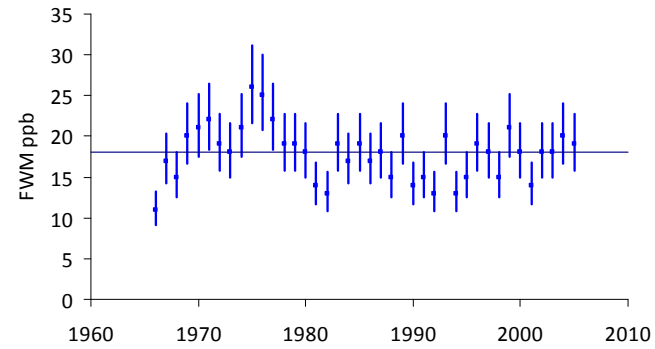

STA5
 ■ FWM
 — 18 ppb

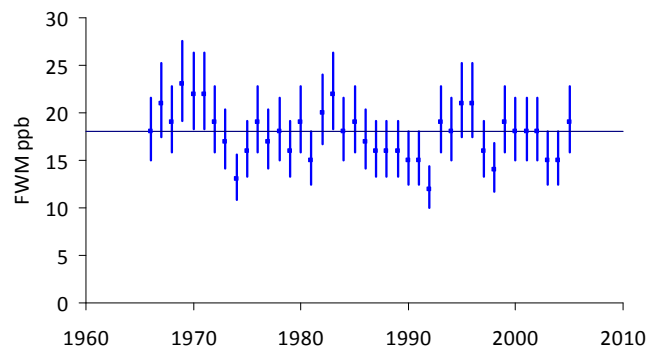

STA2B
 ■ FWM
 — 18 ppb

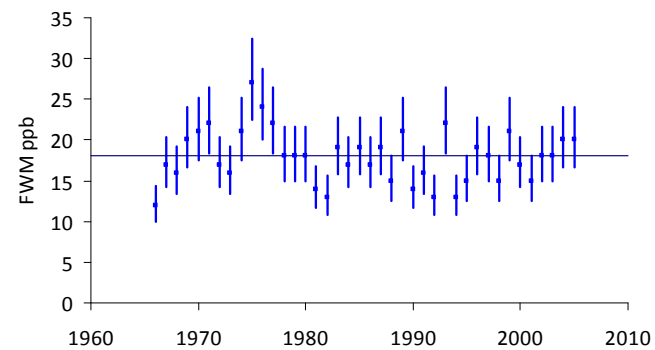

STA6
 ■ FWM
 — 18 ppb

Model Predictions +/- 20%; Rounded to nearest ppb. Solid Line = 18 ppb WQBEL.

Scenario 6 C - C51E Div/FEB, STA Expan

80% Confidence Intervals for Yearly Flow-Weighted Means

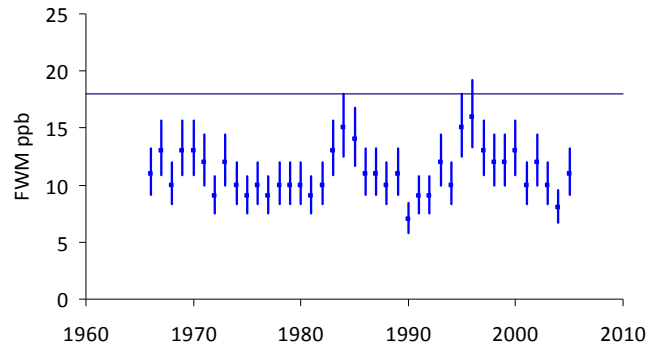

STA1E
 ■ FWM
 — 18 ppb

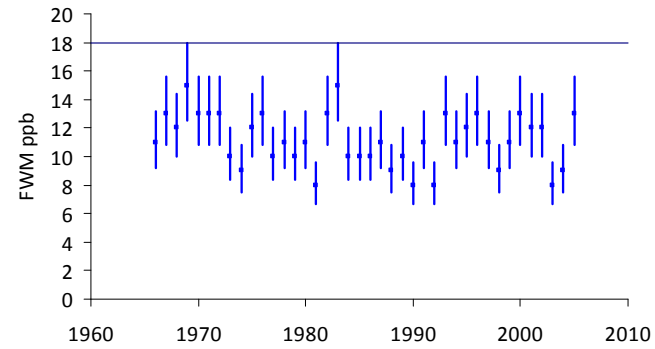

STA34
 ■ FWM
 — 18 ppb

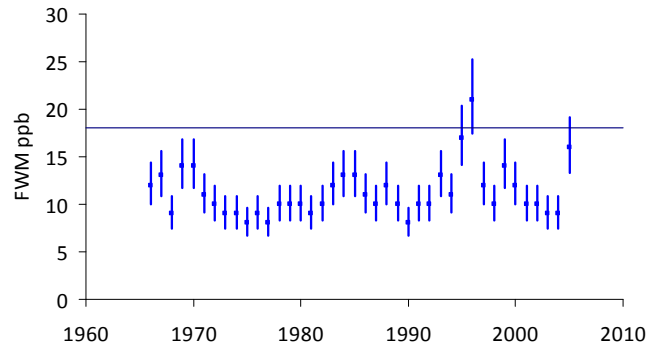

STA1W
 ■ FWM
 — 18 ppb

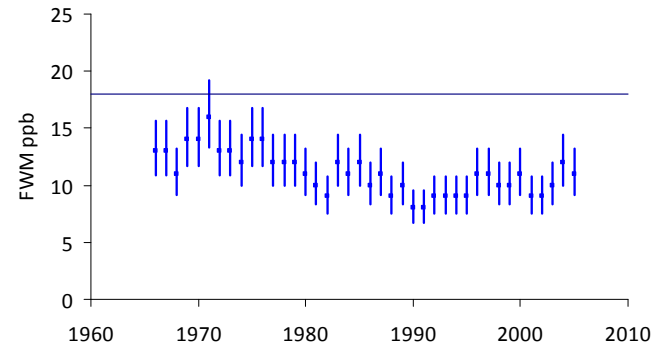

STA5
 ■ FWM
 — 18 ppb

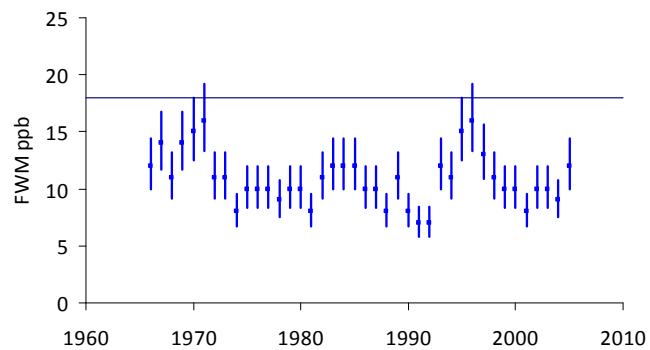

STA2B
 ■ FWM
 — 18 ppb

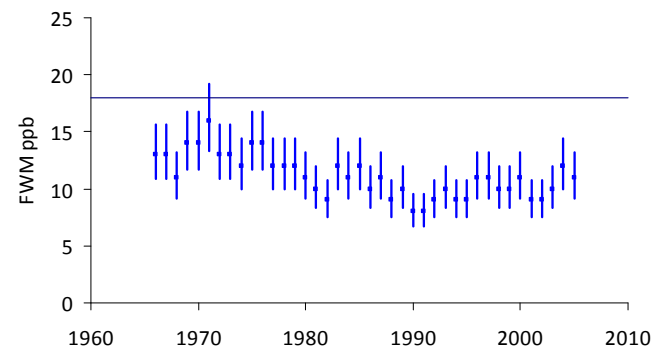

STA6
 ■ FWM
 — 18 ppb

Model Predictions +/- 20%; Rounded to nearest ppb. Solid Line = 18 ppb WQBEL.

Scenario 7 D -C51E Div/FEB, A2 FEB/ STA

80% Confidence Intervals for Yearly Flow-Weighted Means

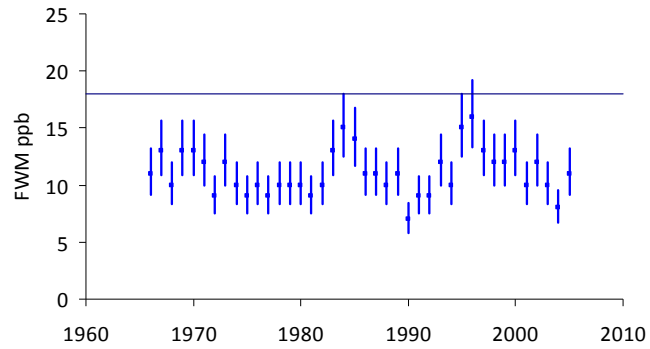

STA1E
 ■ FWM
 — 18 ppb

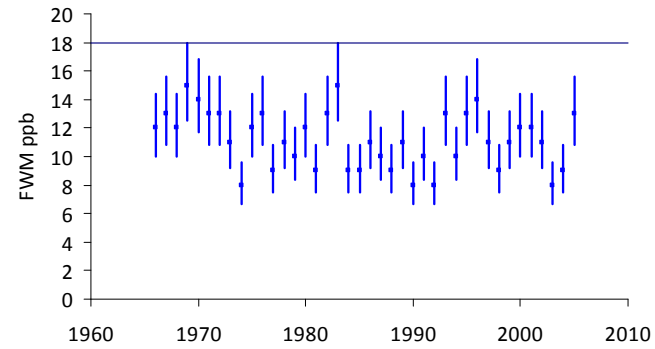

STA34
 ■ FWM
 — 18 ppb

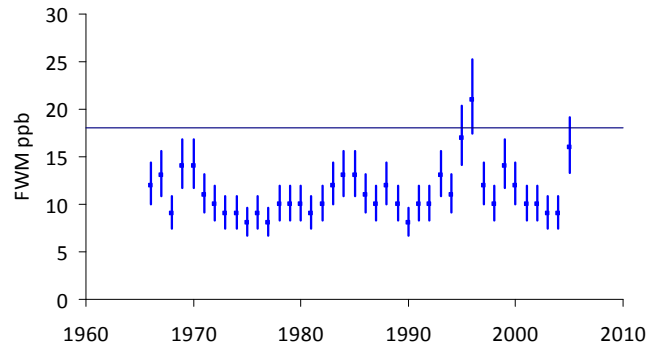

STA1W
 ■ FWM
 — 18 ppb

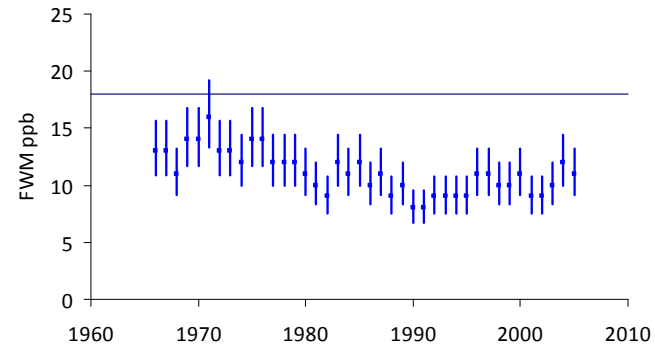

STA5
 ■ FWM
 — 18 ppb

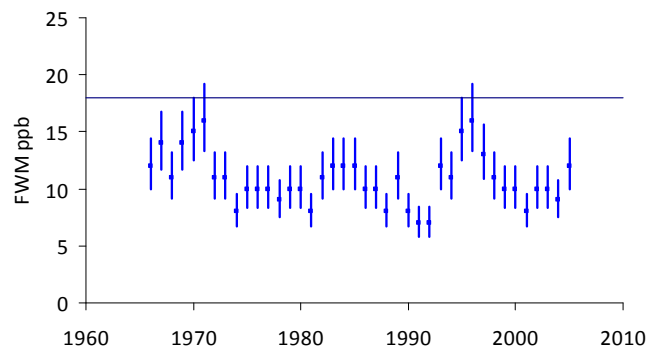

STA2B
 ■ FWM
 — 18 ppb

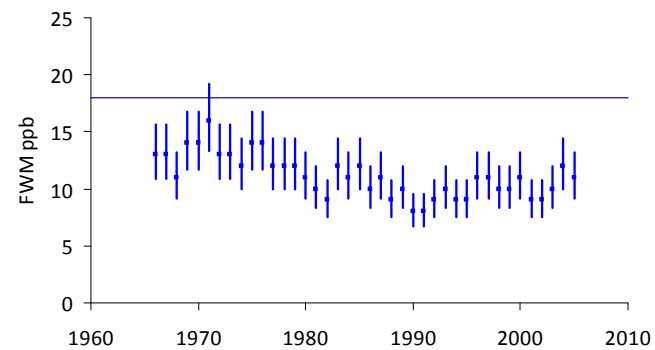

STA6
 ■ FWM
 — 18 ppb

Model Predictions +/- 20%; Rounded to nearest ppb. Solid Line = 18 ppb WQBEL.

Scenario 8 C/D - Interim Plan with C51E Div/FEB

80% Confidence Intervals for Yearly Flow-Weighted Means

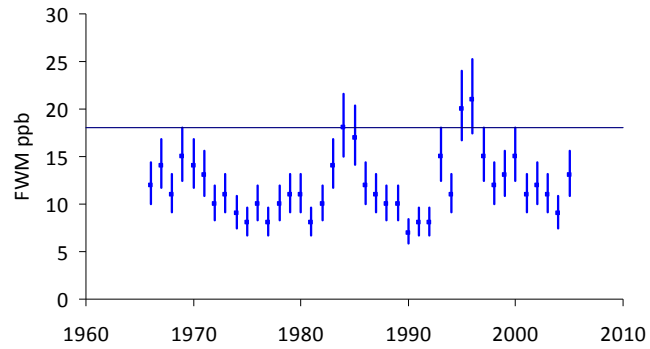

STA1E
 ■ FWM
 — 18 ppb

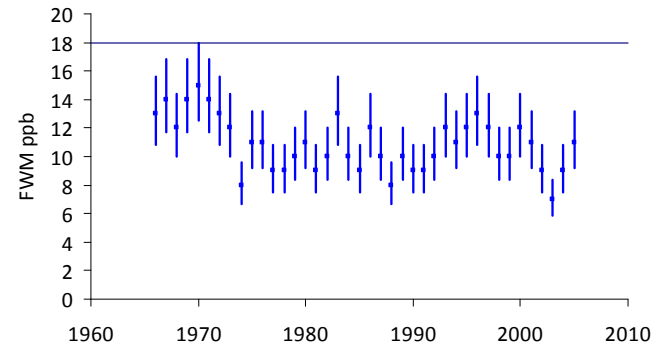

STA34
 ■ FWM
 — 18 ppb

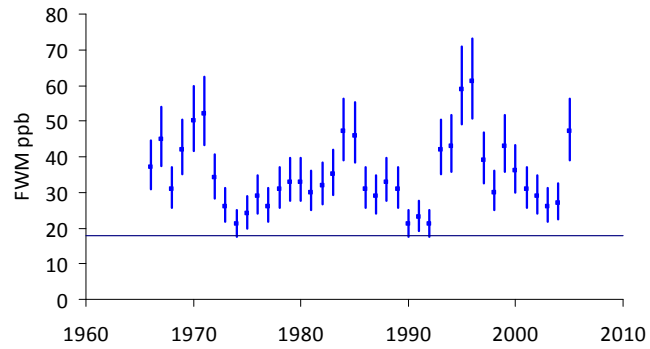

STA1W
 ■ FWM
 — 18 ppb

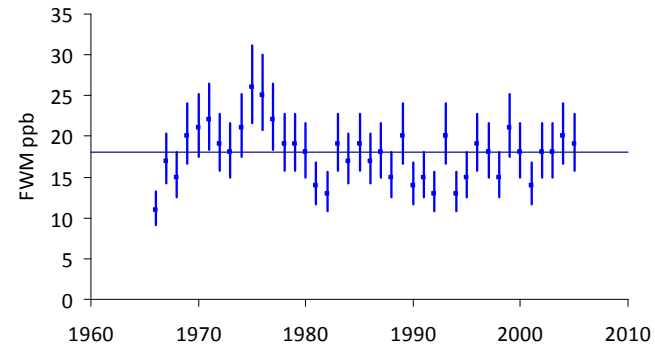

STA5
 ■ FWM
 — 18 ppb

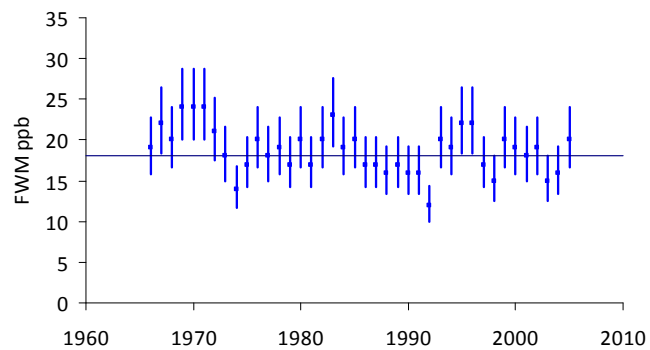

STA2B
 ■ FWM
 — 18 ppb

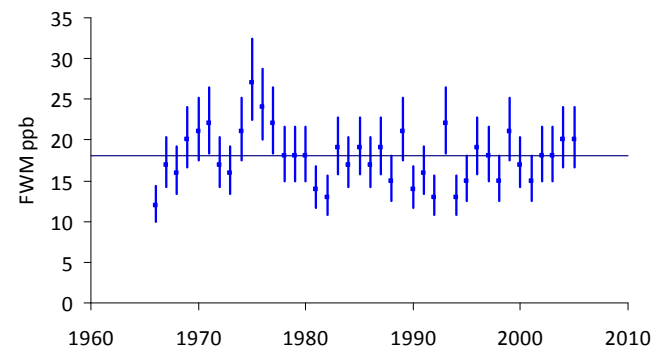

STA6
 ■ FWM
 — 18 ppb

Model Predictions +/- 20%; Rounded to nearest ppb. Solid Line = 18 ppb WQBEL.

Evaluation of Alternatives to Achieve Phosphorus WQBELs
in Discharges to the Everglades Protection Area

prepared for

U.S. Environmental Protection Agency

By

William W. Walker, Jr., Ph.D

Environmental Engineer

Concord, Massachusetts

<http://www.wwwalker.net>

Sept 2, 2010

Attachment 2 : Yearly Geometric Mean Time Series for Each Scenario

Scenario 1 Existing STAs

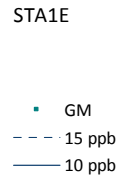
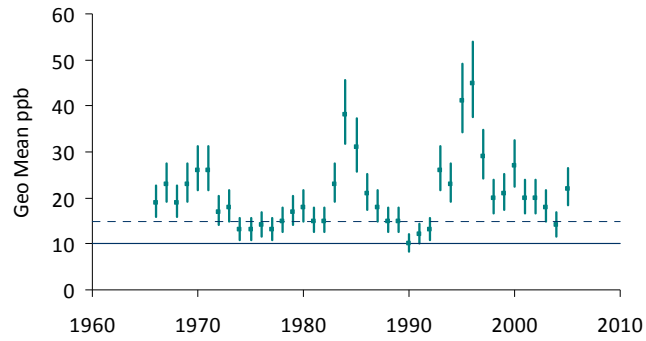

80% Confidence Intervals for Yearly Geometric Means

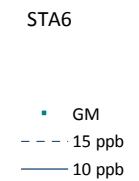
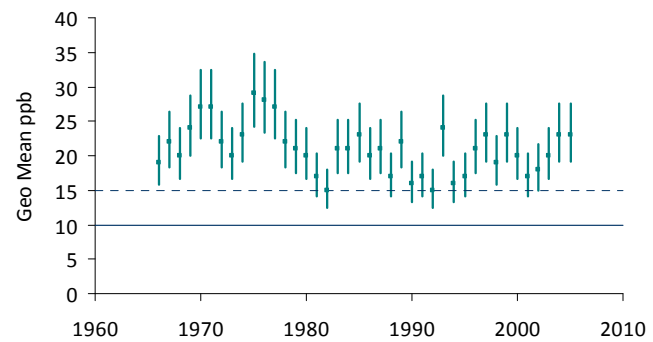
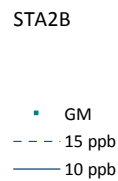
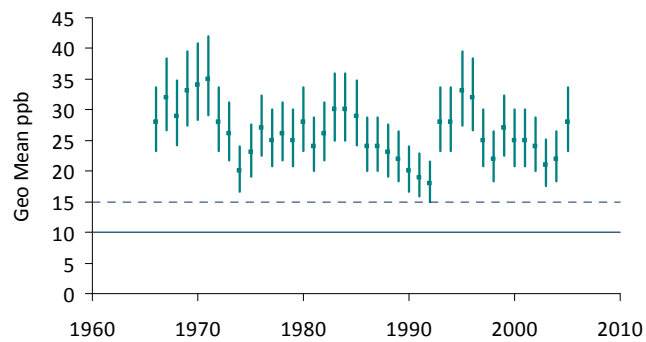
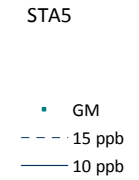
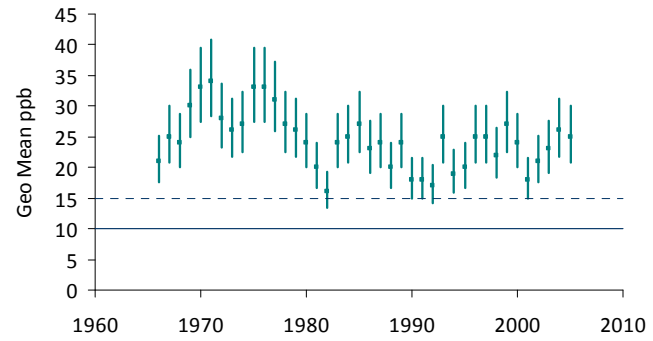
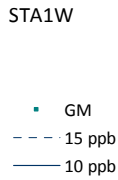
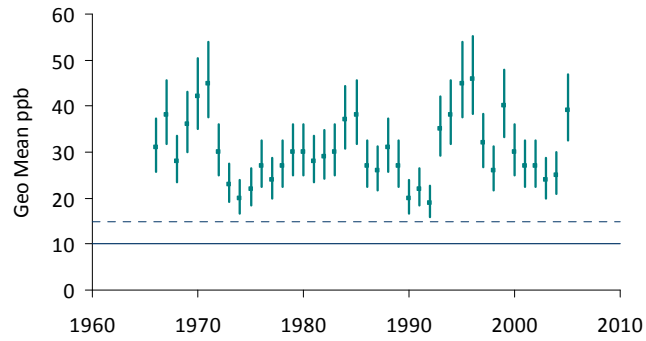
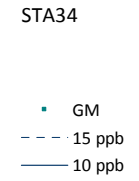
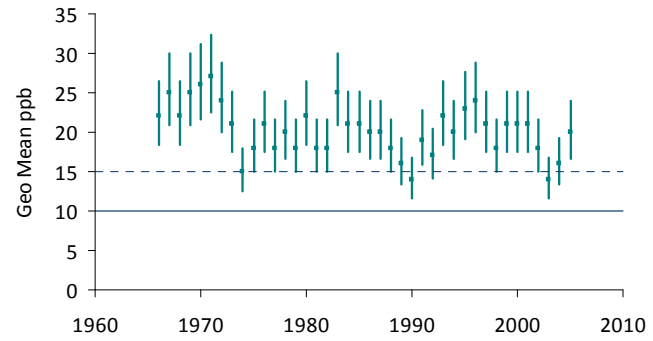

Model Predictions +/- 20%; Yearly Geo Mean = FWM / 1.23. Solid Line = 10 ppb criterion. Dotted Line = 15 ppb limit for marsh sites in 4-Part Test

Scenario 2 Existing STAs + Compartments B & C

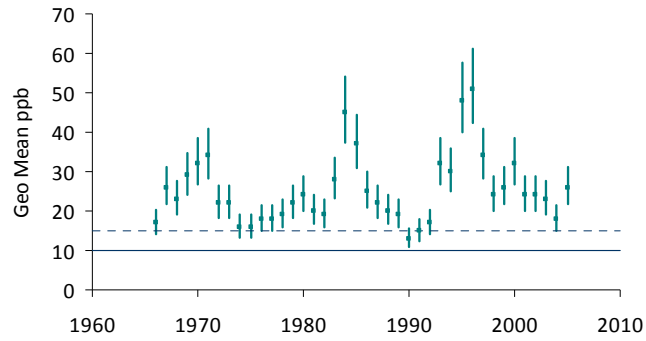

STA1E
 ■ GM
 - - - 15 ppb
 — 10 ppb

80% Confidence Intervals for Yearly Geometric Means

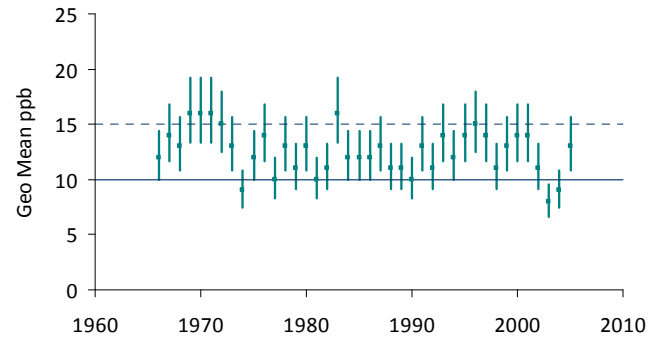

STA34
 ■ GM
 - - - 15 ppb
 — 10 ppb

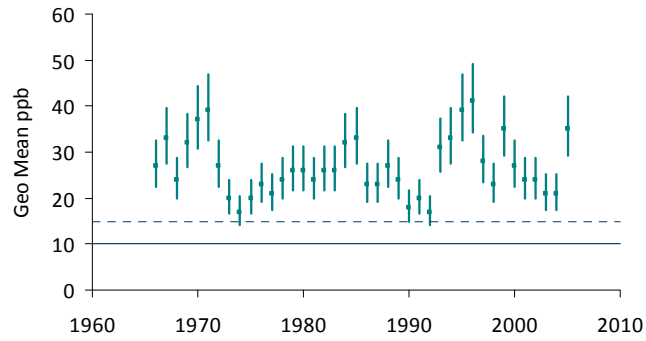

STA1W
 ■ GM
 - - - 15 ppb
 — 10 ppb

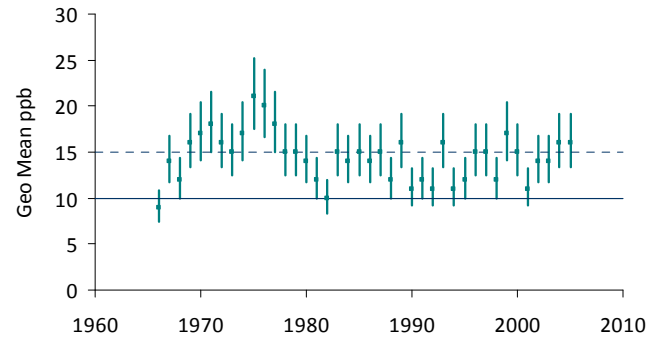

STA5
 ■ GM
 - - - 15 ppb
 — 10 ppb

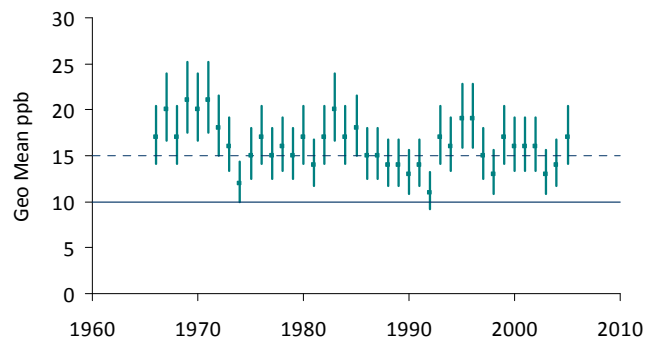

STA2B
 ■ GM
 - - - 15 ppb
 — 10 ppb

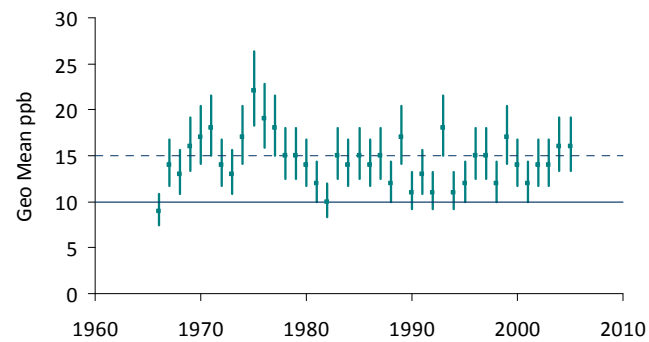

STA6
 ■ GM
 - - - 15 ppb
 — 10 ppb

Model Predictions +/- 20%; Yearly Geo Mean = FWM / 1.23. Solid Line = 10 ppb criterion. Dotted Line = 15 ppb limit for marsh sites in 4-Part Test

Scenario 3 A- STA Expansion

80% Confidence Intervals for Yearly Geometric Means

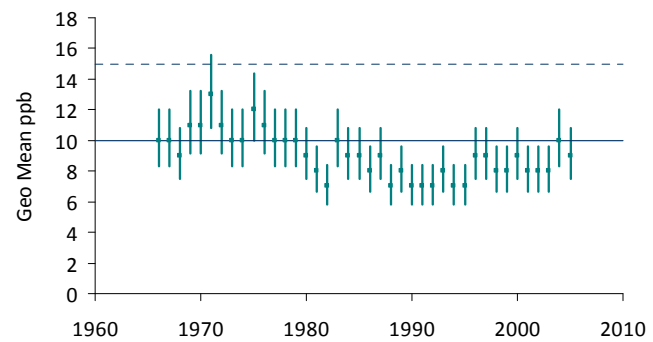
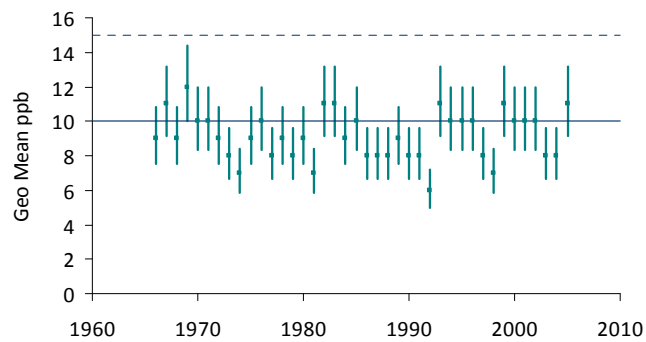
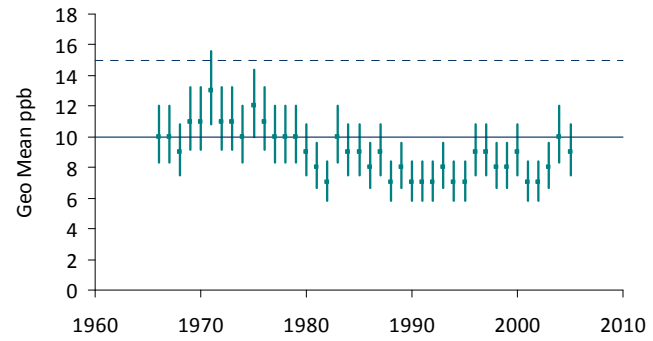
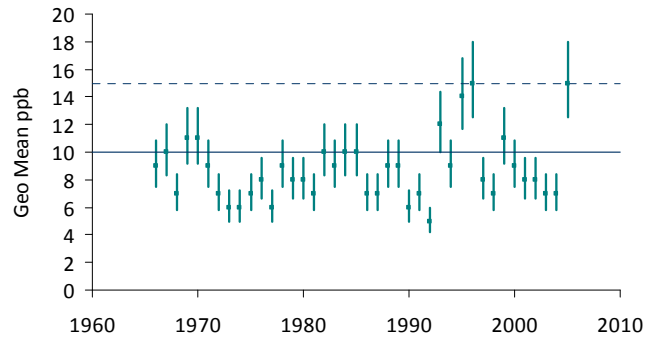
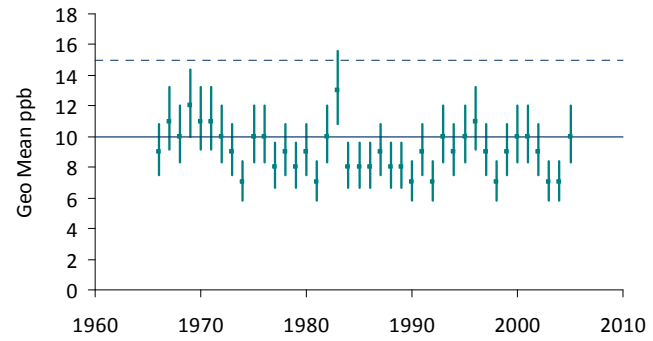
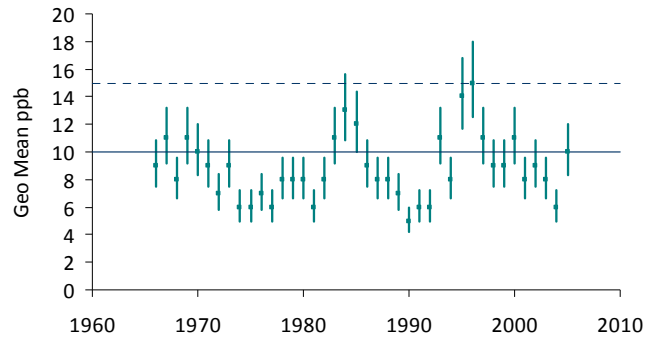

Model Predictions +/- 20%; Yearly Geo Mean = FWM / 1.23. Solid Line = 10 ppb criterion. Dotted Line = 15 ppb limit for marsh sites in 4-Part Test

Scenario 4 B- STA Expansion with A2 FEB

80% Confidence Intervals for Yearly Geometric Means

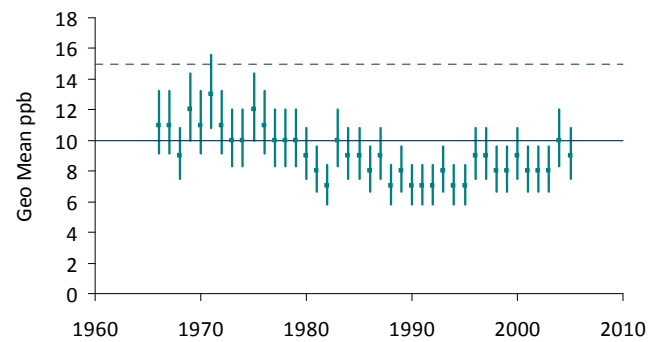
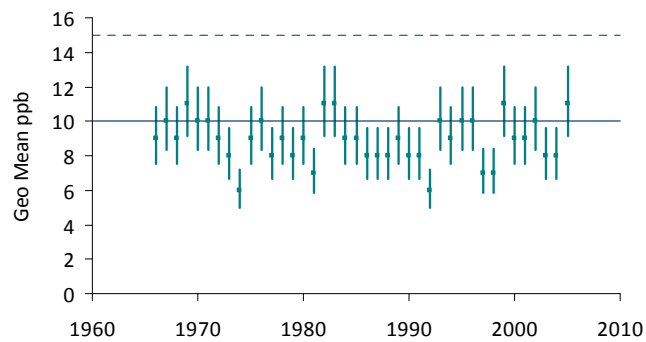
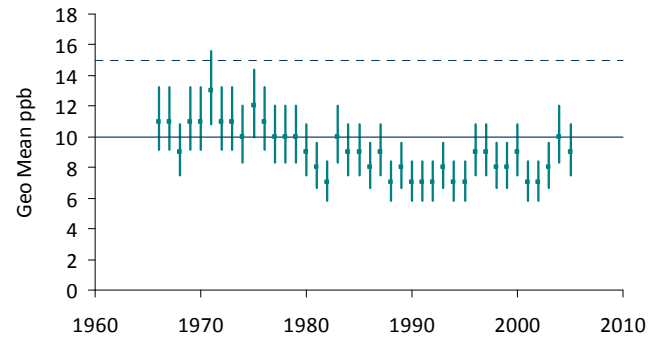
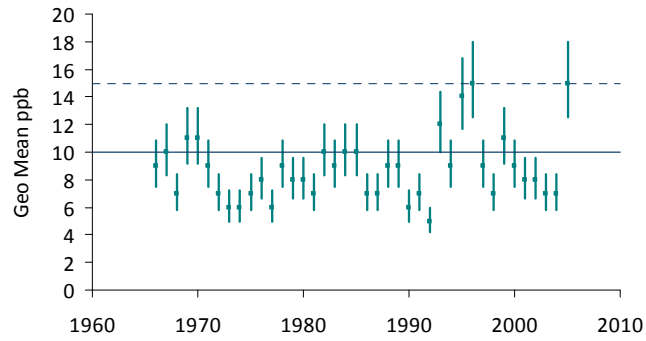
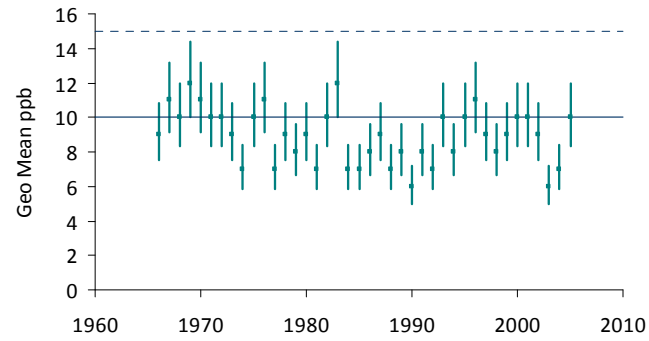
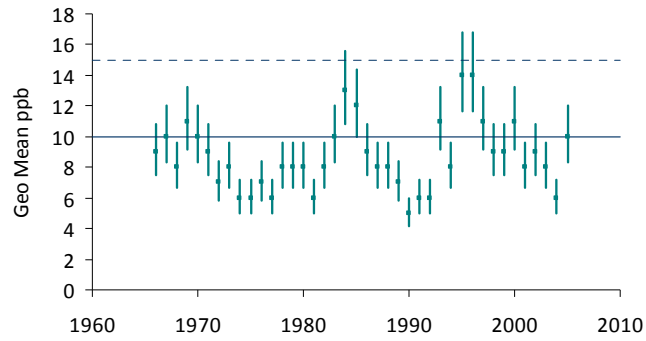

Model Predictions +/- 20%; Yearly Geo Mean = FWM / 1.23. Solid Line = 10 ppb criterion. Dotted Line = 15 ppb limit for marsh sites in 4-Part Test

Scenario 5 A/B - Interim Plan without C51E Div/FEB

80% Confidence Intervals for Yearly Geometric Means

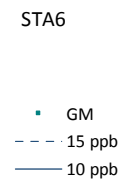
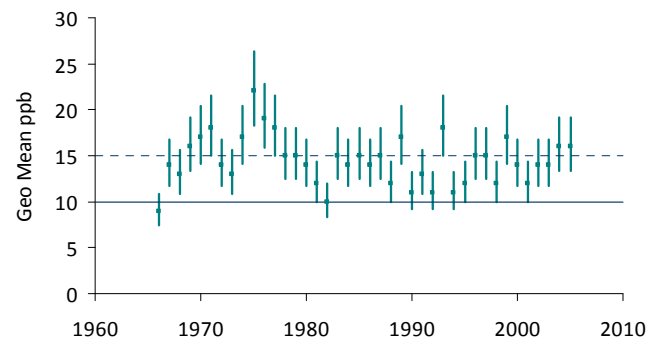
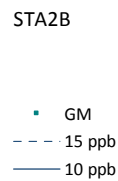
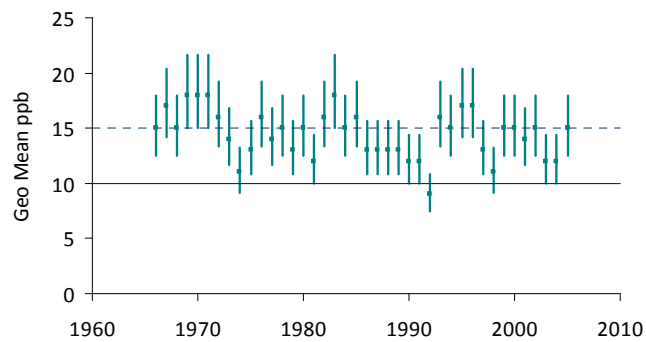
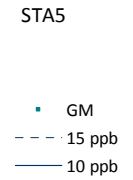
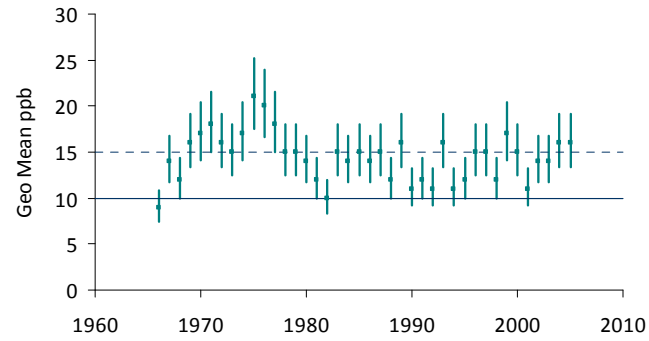
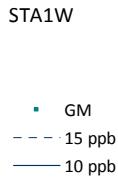
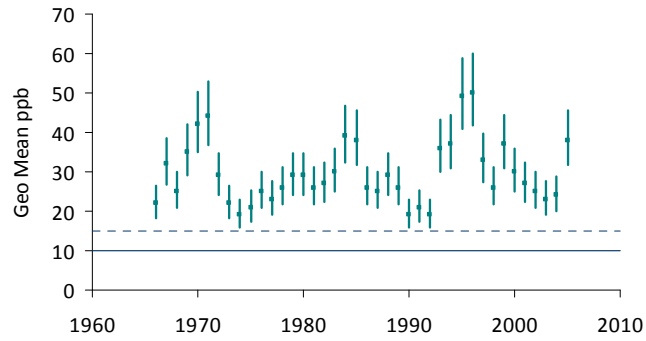
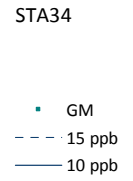
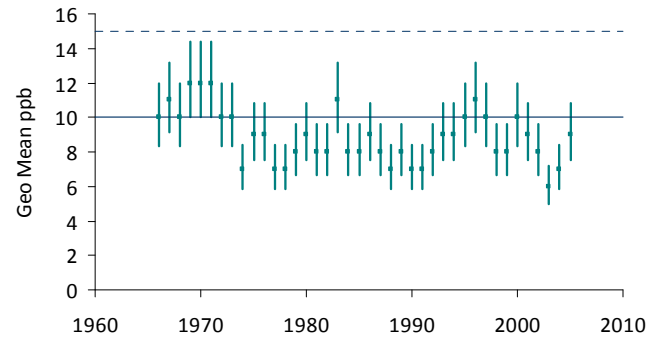
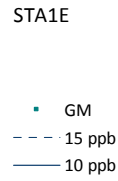
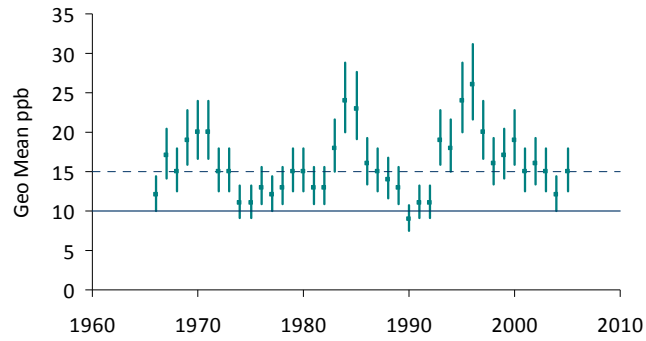

Model Predictions +/- 20%; Yearly Geo Mean = FWM / 1.23. Solid Line = 10 ppb criterion. Dotted Line = 15 ppb limit for marsh sites in 4-Part Test

Scenario 6 C - C51E Div/FEB, STA Expan

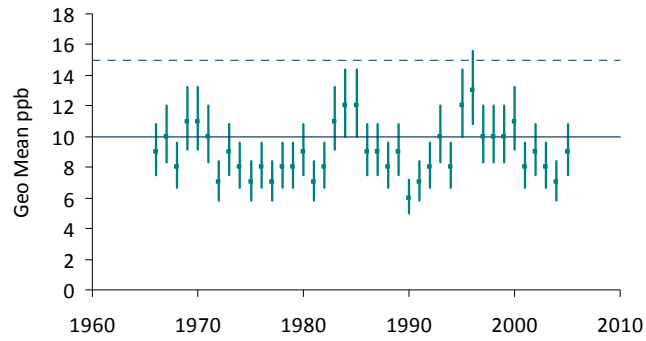

STA1E
■ GM
- - - 15 ppb
— 10 ppb

80% Confidence Intervals for Yearly Geometric Means

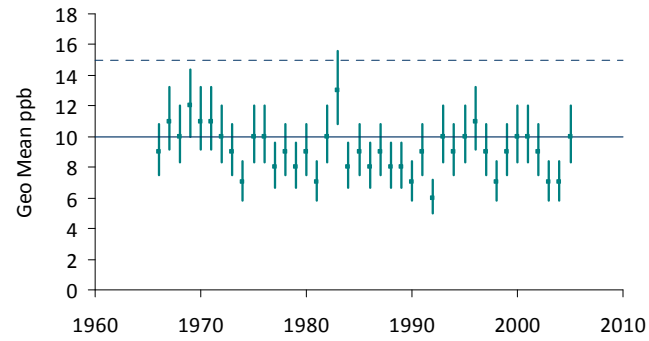

STA34
■ GM
- - - 15 ppb
— 10 ppb

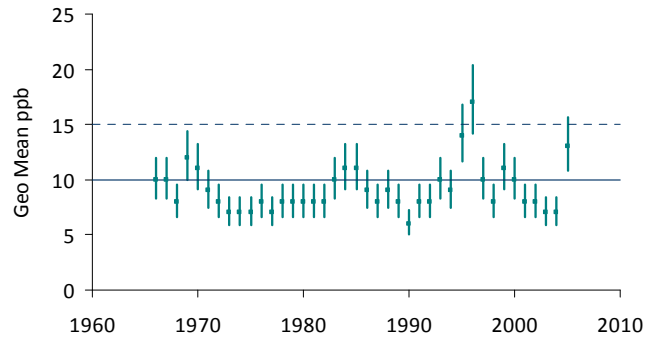

STA1W
■ GM
- - - 15 ppb
— 10 ppb

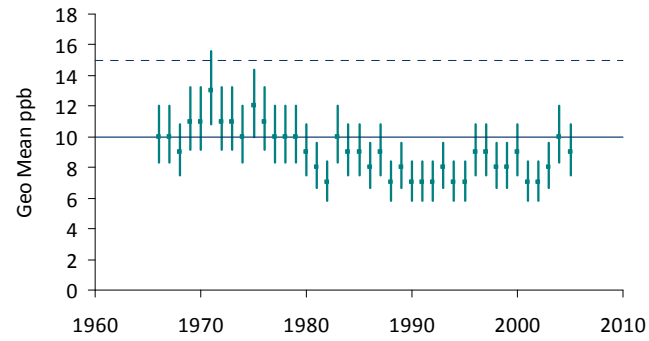

STA5
■ GM
- - - 15 ppb
— 10 ppb

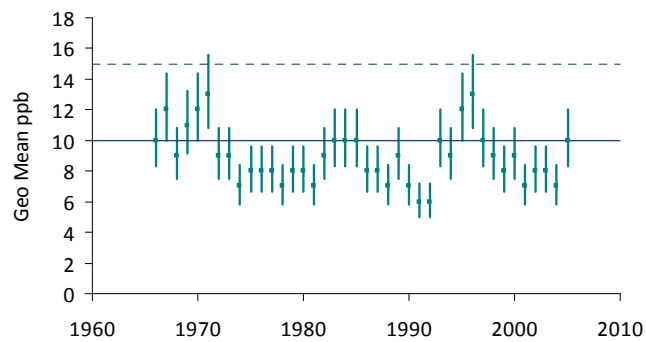

STA2B
■ GM
- - - 15 ppb
— 10 ppb

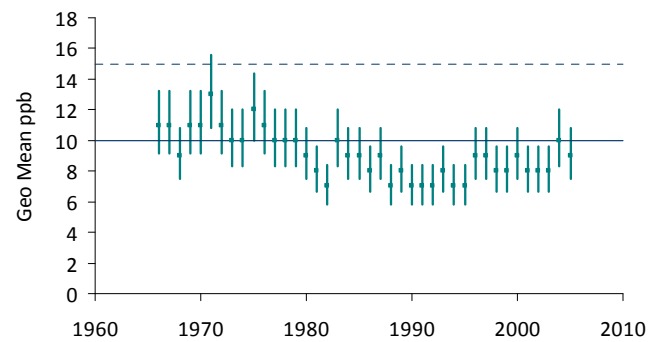

STA6
■ GM
- - - 15 ppb
— 10 ppb

Model Predictions +/- 20%; Yearly Geo Mean = FWM / 1.23. Solid Line = 10 ppb criterion. Dotted Line = 15 ppb limit for marsh sites in 4-Part Test

Scenario 7 D -C51E Div/FEB, A2 FEB/ STA

80% Confidence Intervals for Yearly Geometric Means

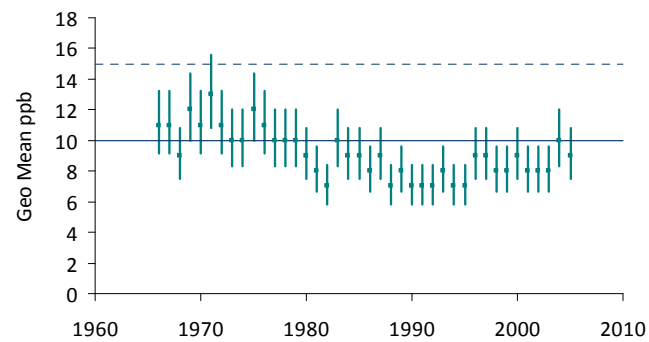
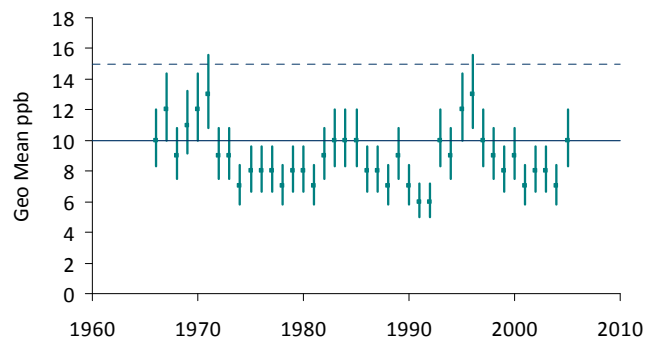
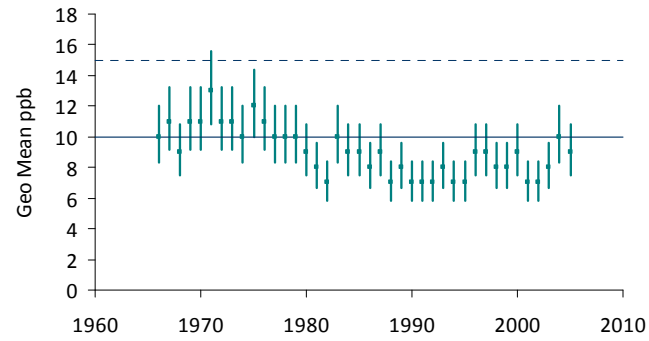
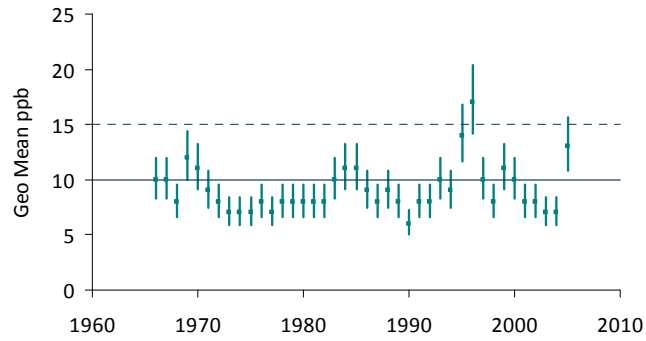
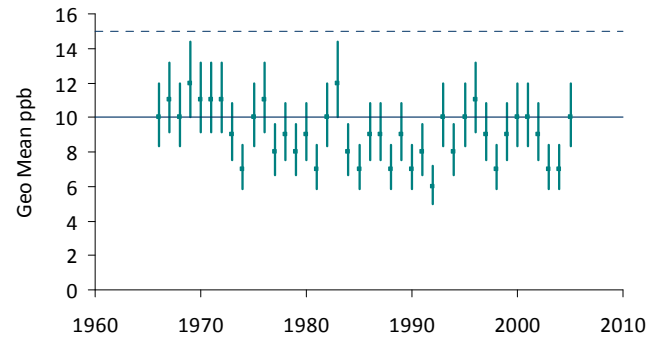
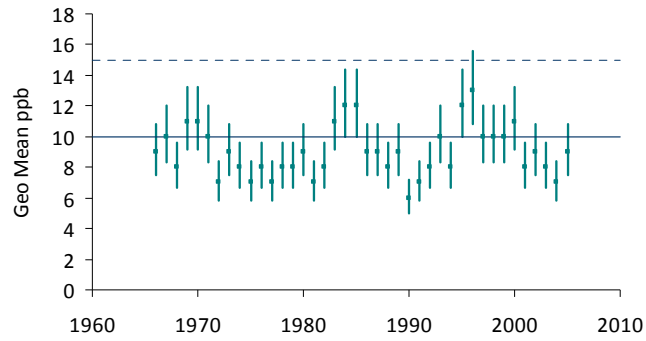

Model Predictions +/- 20%; Yearly Geo Mean = FWM / 1.23. Solid Line = 10 ppb criterion. Dotted Line = 15 ppb limit for marsh sites in 4-Part Test

Scenario 8 C/D - Interim Plan with C51E Div/FEB

80% Confidence Intervals for Yearly Geometric Means

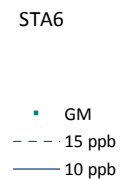
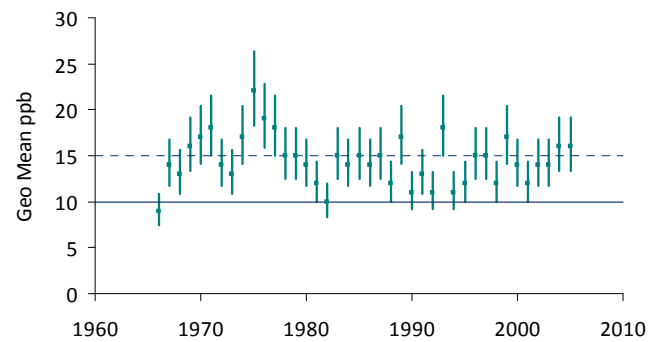
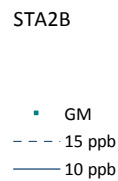
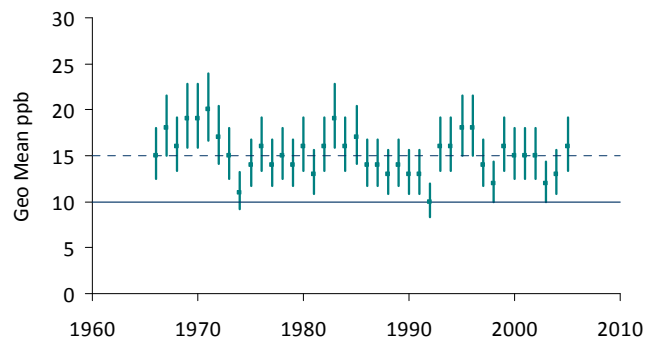
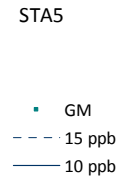
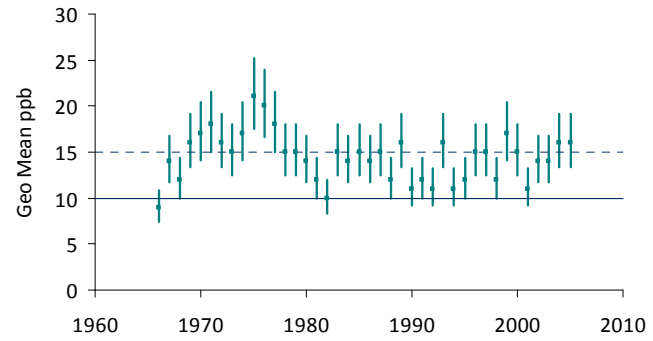
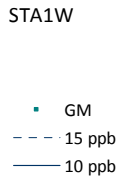
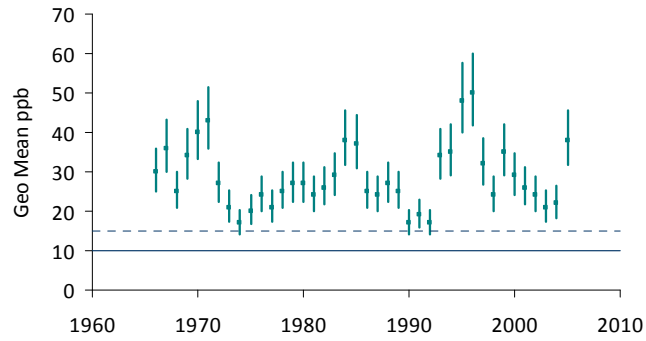
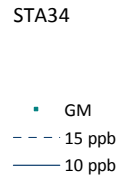
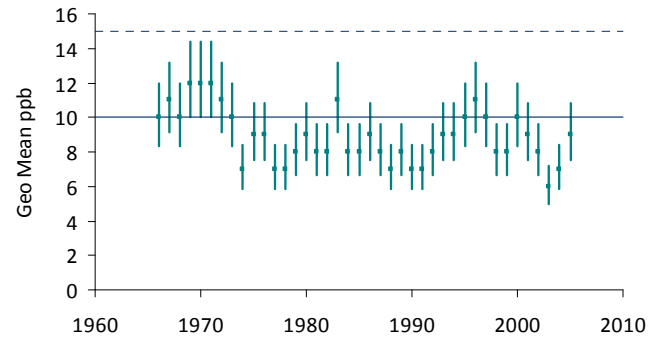
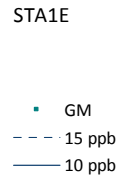
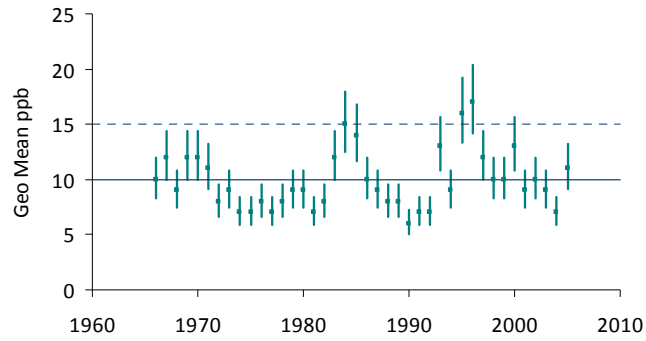

Model Predictions +/- 20%; Yearly Geo Mean = FWM / 1.23. Solid Line = 10 ppb criterion. Dotted Line = 15 ppb limit for marsh sites in 4-Part Test

Evaluation of Alternatives to Achieve Phosphorus WQBELs
in Discharges to the Everglades Protection Area

prepared for

U.S. Environmental Protection Agency

By

William W. Walker, Jr., Ph.D

Environmental Engineer

Concord, Massachusetts

<http://www.wwwalker.net>

Sept 2, 2010

Attachment 3 : Scenario Flow Charts

Scenario	Description
0	Generalized Project Schematic
1	Existing STAs
2	Existing STAs + Compartments B & C
3	A- STA Expansion Only
4	B- STA Expansion with A1 STA & A2 FEB
5	A/B - Interim Plan with Temporary A1 FEB & Balance STA-34 Inflow
6	C - C51E Diversion /FEB, STA Expansion
7	D - C51E Diversion/FEB, A2 FEB+STA, A1 STA
8	C/D - Interim Plan with Temporary A1 FEB, Balance STA-34 Inflow, C51E Div/FEB

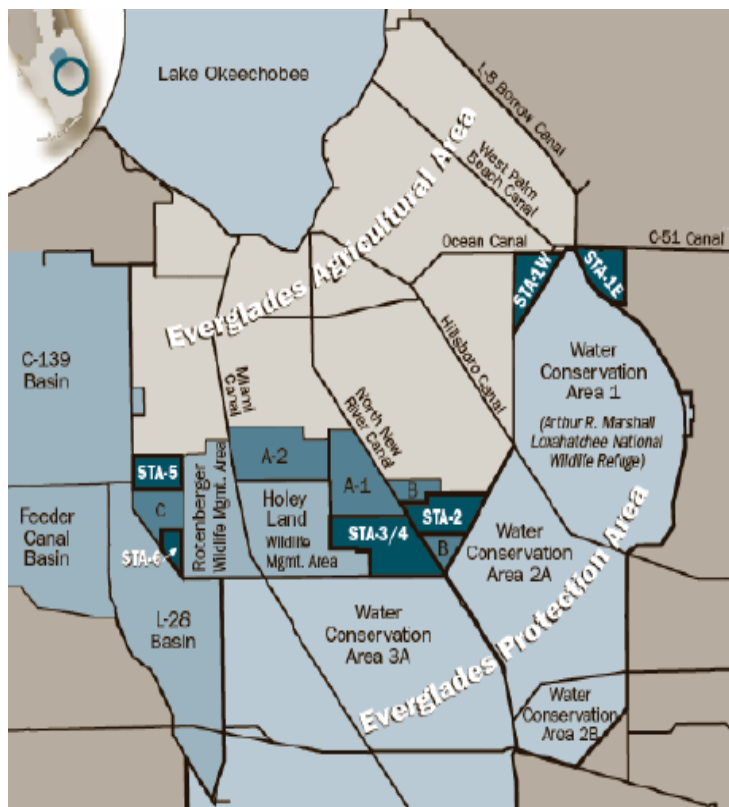

Generalized Flow Chart for WQBEL Scenarios

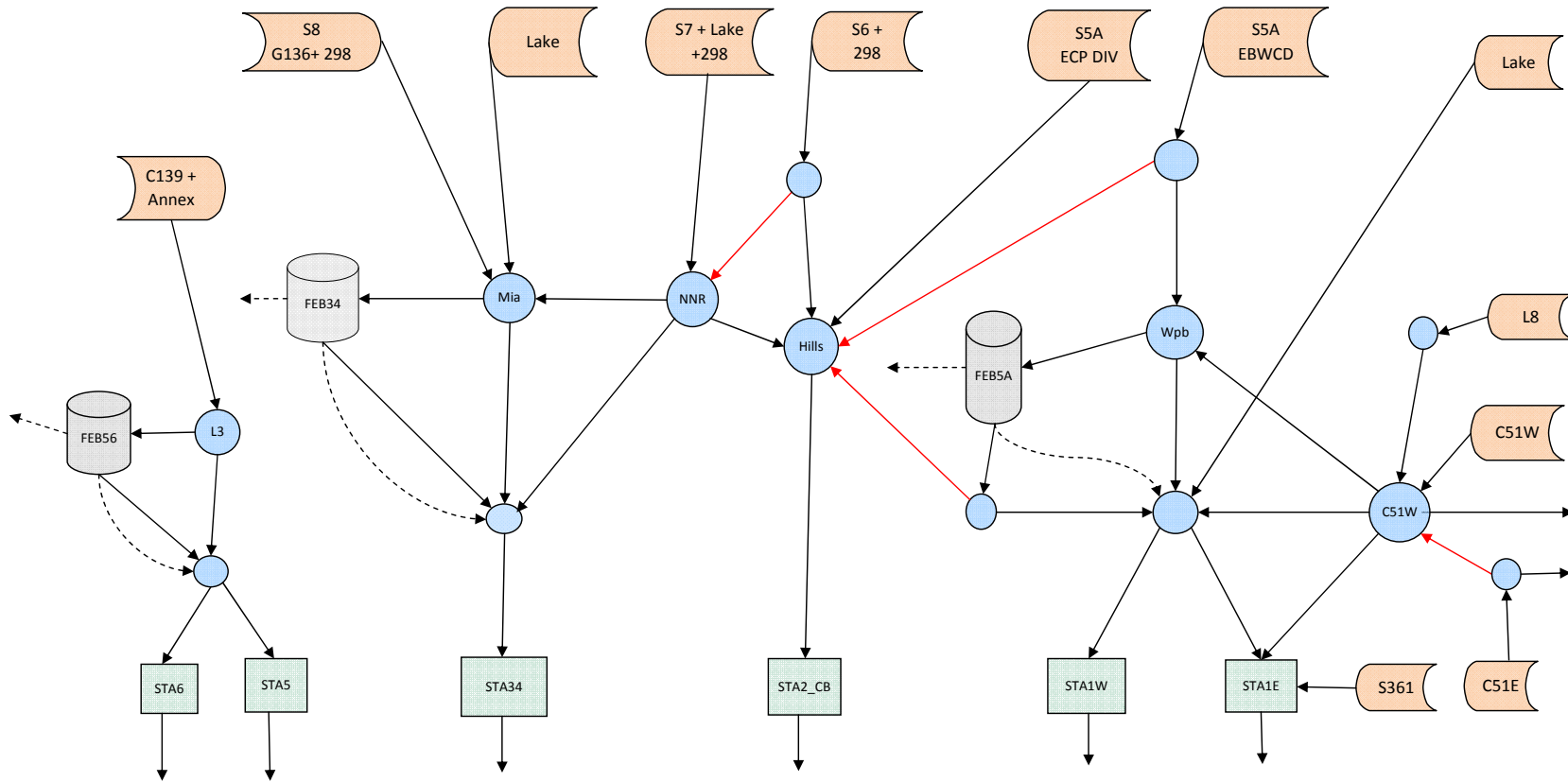

- Flow Path
- New Diversion
- - - - - FEB Releases for STA Irrigation, Urban Water Supply (S5A), or Farm Irrigation (None Assumed)

Schematic reflects the general logic of the flow network, not specific locations of the project components
 Expanded STA's are modeled as additional flow paths for STA-6, STA-34, and STA-1W.

Scenario: 1 Existing STAs

Mean Flow kac-ft/yr

STA Expansion kac

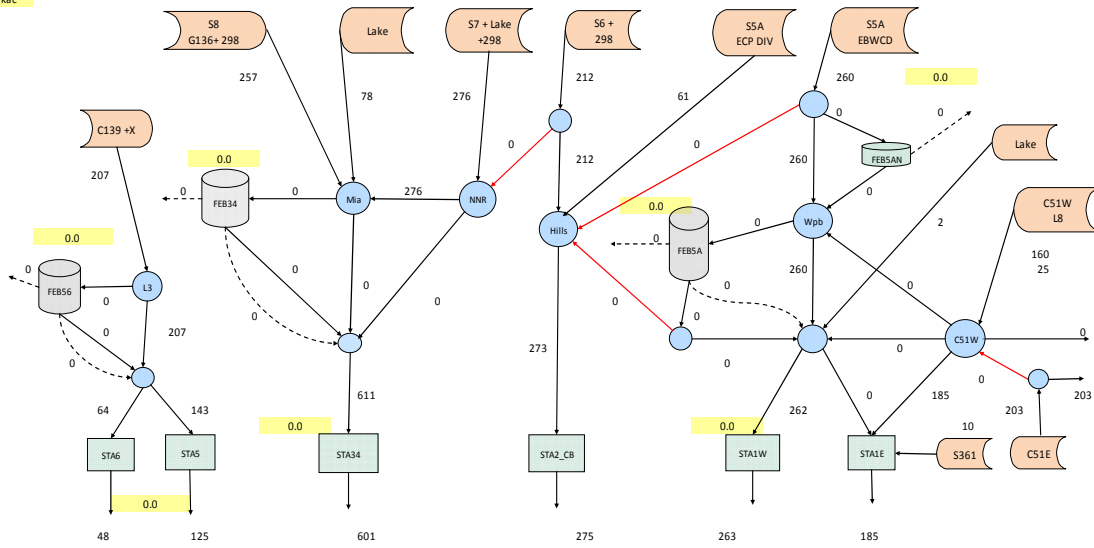

STA Outflow TP	ppb	26.5	30.9	25.5	33.2	39.1	28.2	Totals	30.1
STA Expansion	kac	0.0	0.0	0.0	0.0	0.0	0.0		0.0
STA Total Area	kac	2.8	6.1	16.5	8.2	6.7	5.1		45.5
STA Outflow	kac/yr	48	125	601	275	263	185		1497
WCA Inflow	kacft			774					1497

Inputs for Scenario EvenLess No Expansion or Source Control, Before Comp B & Comp C Operating

Diversion Rules		Diverted to		Fraction	Qmax	Description	Mass Balance Summary		EvenLess	project_evenless.xls	Run Date 9/1/10 19:58				
Diversion	Default	Diverted to	Fraction	Qmax	Description	Area	Inflows	Load	Conc	Flow	Load	Conc	HLR	HLR Max	
CS1E Diversion	CS1W Canal	EAST	0	1000		STA	Flow	mt	ppb	kac-ft	mt	ppb	cm/d	cm/d	
SSA Div (ECART)	SSA Div	HILLS_C	0	800	divert to hills	STA1E	194	37.3	155	185	6.5	28.2	3.16	20.1	
SSA Div (ECART)	SSA Div	HILLS_C	0	200	low-flow bypass to WPB	STA1W	262	68.0	210	263	12.7	39.1	3.28	20.6	
SSA Div to FEB	FEBSSA	FEBSSA_N	0		northern STA.FEB	STA2B	50.2	149	275	11.3	33.2	2.77	14.0		
FEB SSA Outflow	STA1DW	HILLS_C	0		diversion to Hills	STA34	16.5	611	92.6	601	18.9	25.5	3.08	13.1	
CS1W Outflow	EAST	STA1E	1		direct to STA1E	STA5	6.1	143	37.8	214	12.5	4.8	30.9	1.96	8.9
CS1W Outflow	EAST	STA1_DW	1		direct to STA1DW	STA6	2.8	64	17.0	214	4.8	1.6	26.5	1.92	8.7
CS1W Outflow	EAST	FEB_S5A	1		remainder to East	Total STA	45.5	1548	302.7	158	1497	55.7	30.1	2.84	
STA1W Distrib	STA1W	STA1E	0		WPB C STA1E										
S6 Runoff	STA2CB	NNRC	0		S6 divert to NNR										
NNR Canal	FEB34	STA34	0		NNR LowQ Bypass to STA34										
STA56 Distrib	STA5	STA6	0.31		Balance STA56 Loads, Hint=										

FEB Calculations	FEB_S5A	FEB_34	FEB_56	FEBSSA_N	FEBs	Area	Flow	Load	Conc	Flow	Load	Conc	Depth	cm
DMSTA calibration	RES_3	RES_3	RES_3	RES_3	FEBSSA_N	kac	kac-ft	mt	ppb	kac-ft	mt	ppb	Mean	Min
Area	60	30	30	30	FEB_S5A_N	0.0	0	0.0	#N/A	0	0.0	#N/A	0	0
HRT days	44	8	4	4	FEB_34	0.0	0	0.0	#N/A	0	0.0	#N/A	0	0
Bypass Depth ft	100	100	100	200	FEB_56	0.0	0	0.0	108	0	0.0	#N/A	0	0
LowQ Bypass cfs	2000	4000	2000	1000	Total FEB	0.0	0	0.0	#N/A	0	0.0	#N/A	0	0
Max Qin cfs	1000	500	500	100										
Max Qout cfs	0.5	0.5	0.5	0.5										
Control Depth ft	0.5	0.5	0.5	0.5										
Min Release Schedule														
Regulation Schedule														
STA WS Release														
Farm WS Release														
Farm Irrig kac														

Input Time Series	Flow	Load	Conc	Flow	Flow CV	Flow Max
TS_FEBSSA_N	0.0	0.0	0	0	#N/A	0
TS_FEBSSA	259.5	67.7	211	358	1.87	5153
TS_STA1DW	2.3	0.3	103	3	9.50	666
TS_STA1W	0.0	0.0	0	0	#N/A	0
TS_STA1E	194.4	37.3	155	268	1.07	3318
TS_STA2B	273.2	50.2	149	377	1.94	3931
TS_FEB34	0.0	0.0	0	0	#N/A	0
TS_STA34	611.0	92.6	123	843	1.80	8891
TS_FEB56	207.1	54.8	214	286	1.20	4806
Total	1547.6	302.7	158	0	0.00	0

Base Period for Concs	1	2	3	4
Use Lake P Concs	TRUE	for S354 & S351	Lake Releases	
C139 Load Reduc	0%	Max TP	ppb	0
STA Duty Cycle	0.95	New Lake Rel	ka	0
Target Conc ppb	12	Iterations	1	use iter=1 for testing, 2 for final
Output Interval Days	30	Other		
SSA Load Reduc	0%	Other		
Other		Other		

Watershed Areas	Land	Fraction	New STA	FEB	Runoff
Scale_s5A	133	1	0.0	0.0	1.00
Scale_s6	105	1			1.00
Scale_s7	120	1	0.0	0.0	1.00
Scale_s8	120	0			1.00
Scale_Annex	18	1	0.0	0.0	1.00

Scenario: 2 Existing STAs + Compartments B & C

Mean Flow kac-ft/yr

STA Expansion kac

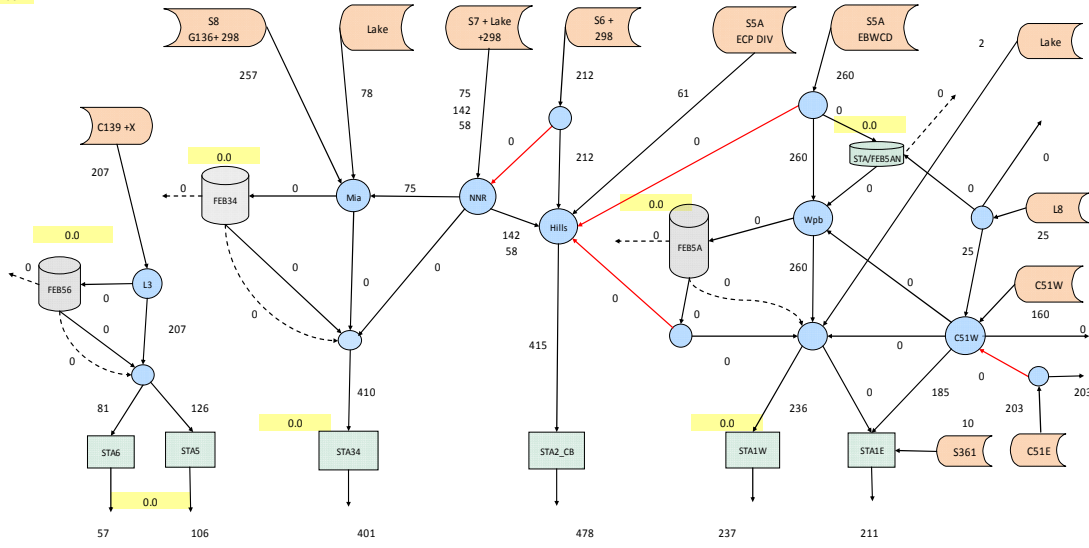

STA Outflow TP ppb	18.3	18.3	15.7	20.3	34.1	34.0	Totals	23.0
STA Expansion kac	0.0	0.0	0.0	0.0	0.0	0.0		0.0
STA Total Area kac	5.1	7.9	16.5	15.1	6.7	5.1		56.5
STA Outflow kac/yr	57	106	401	478	237	211		1490
WCA Inflow kac/ft			564	478	448			1490

Inputs for Scenario Nothing Existing Treatment Capacity: Comp B & Comp C Complete

Diversion Rules		Mass Balance Summary		Nothing		project_nothing.xls		Run Date					
Diversion	Default	Diverted to	Fraction	Qmax	Description	Flow	Load	Conc	Flow	Load	Conc	HLR	HLR Ma
CS1E Diversion	CS1W Canal	EAST	0										
SSA Div (ECART)	SSA Div	HILLS_C	0		divert to hills up to qmax	STA	kac	ppb	kac-ft	mt	ppb	cm/d	cm/d
SSA Div (ECART)	SSA Div	HILLS_C	0		low-flow bypass to WPB	STA1E	5.1	221	44.1	162	211	8.8	34.0
SSA Div to FEB North	FEBSSA	FEBSSA_N	0		northern STA.FEB	STA1W	6.7	236	61.2	210	237	10.0	34.1
FEB SSA Outflow	HILLS_C	STA1DW	0		diversion to Hills	STA2B	15.1	474	79.9	137	478	12.0	20.3
CS1W Outflow	EAST	STA1E	1		direct to STA1E	STA34	16.5	410	62.8	124	401	7.8	15.7
CS1W Outflow	EAST	STA1_DW	0		direct to STA1DW	STA5	7.9	126	33.4	214	106	2.4	18.3
CS1W Outflow	EAST	FEB_S5A	0		remainder to East	STA6	5.1	81	21.4	214	57	1.3	18.3
STA1W Distrib	STA1W	STA1E	0.1		WPB C STA1E	Total STA	56.5	1548	302.7	158	1490	42.3	23.0
S6 Runoff	STA2CB	NNRC	0		S6 divert to NNR								
NNR Canal	FEB34	STA34	0		NNR LowQ Bypass to STA34				STA1W+E	448.0	18.8	34.1	
STA56 Distrib	STA5	STA6	0.39		Balance STA56 Loads, HInt= 0.394				STA2+34+B	879.3	19.8	18.2	
L8 to STA1N	CS1W	FEBSSA_N	0		To FEB SSAN (Rest to CS1W)				STA5+6	163.1	3.7	18.3	
L8 to North	CS1W	North	0		CERP								
NNR to CB	STA34	Comp B	1		Original Design for Comp B=1								
NNR to CB 2	STA34	Comp B	0.48		Additional NNR Diversion to CB								

FEB Calculations	FEB_S5A	FEB_S6	FEB_S5A_N	FEBs	Area	Flow	Load	Conc	Flow	Load	Conc	Depth cm
DMSTA calibration	RES_3	RES_3	RES_3	EMG_3	kac	kac-ft	mt	ppb	kac-ft	mt	ppb	Mean
Area kac					0.0	0.0	0.0	#N/A	0	0.0	#N/A	0
HRT days	14	14	30	30	0.0	0.0	0.0	#N/A	0	0.0	#N/A	0
Bypass Depth ft	26.4	4	12	4	0.0	0.0	0.0	#N/A	0	0.0	#N/A	0
LowQ Bypass cfs	200	400	50	100	0.0	0.0	0.0	#N/A	0	0.0	#N/A	0
Max Qin cfs	2000	2775	2500	2000	0.0	0.0	0.0	68	0	0.0	#N/A	0
Max Qout cfs	1000	1000	500	500	0.0	0.0	0.0	#N/A	0	0.0	#N/A	0
Control Depth ft	0.5	0.5	0.5	0.5								
Min Release Depth ft	0.5	0.5	0.5	0.5								
Regulation Schedule	FEB_REG	FEB_REG	FEB_REG		Optional:							
STA WS Release	REL_STA	REL_STA	REL_STA		See FEB_Design Sheet	Input Time Series	Flow	Load	Conc	Flow	Flow CV	Flow Max
Farm WS Release				REL_FARM	See input series sheet		kac-ft	mt	ppb	cfs	-	cfs
Frac Irrig Demand	0.5			0.25	""	TS_FEBSSA_N	0.0	0.0	0	0	#N/A	0
Frac CS1 Urban WS	1					TS_FEBSSA	259.5	67.7	211	358	1.87	5153
STA Expansion	STA1WX	STA34X	STA56X			TS_STA1DW	2.3	0.3	103	3	9.50	666
Area kac	0	0	0			TS_STA1W	0.0	0.0	0	0	#N/A	0
Fraction SAV	0.67	0.67	0.4			TS_STA1E	194.4	37.3	155	268	1.07	3318
Enhanced	SAV_3	SAV_3	PEW_3			TS_STA2B	473.7	79.9	137	654	2.02	6863
						TS_FEB34	0.0	0.0	0	0	#N/A	0
						TS_STA34	410.5	62.8	124	567	1.75	5959
						TS_FEB56	207.1	54.8	214	286	1.20	4806
						Total	1547.6	302.7	158	0	0.00	0

Base Period for Concs	1	1= 2005-2009, 2 = 1995-2009
Use Lake P Concs	TRUE	for S354 & S351 Lake Releases
C139 Load Reduc	0%	Max TP ppb 0
STA Duty Cycle	0.95	New Lake Rel ka 0
Target Conc ppb	11.5	Iterations 1 use iter=1 for testing, 2 for final
Output Interval	30	SSA/CS1 Cmax 0
SSA Load Reduc	0%	S678 Cmax 0
Other		C139 Cmax 0

Watershed Areas	Land kac	Fraction	New STA kac	FEB kac	Runoff Rescale
Scale_s5A	133	1	0.0	0.0	1.00
Scale_s6	105	1			1.00
Scale_s7	120	1	0.0	0.0	1.00
Scale_s8	120	0			1.00
Scale_Annex	18	1	0.0	0.0	1.00

Scenario: 3 A- STA Expansion Only

Mean Flow kac-ft/yr

STA Expansion kac

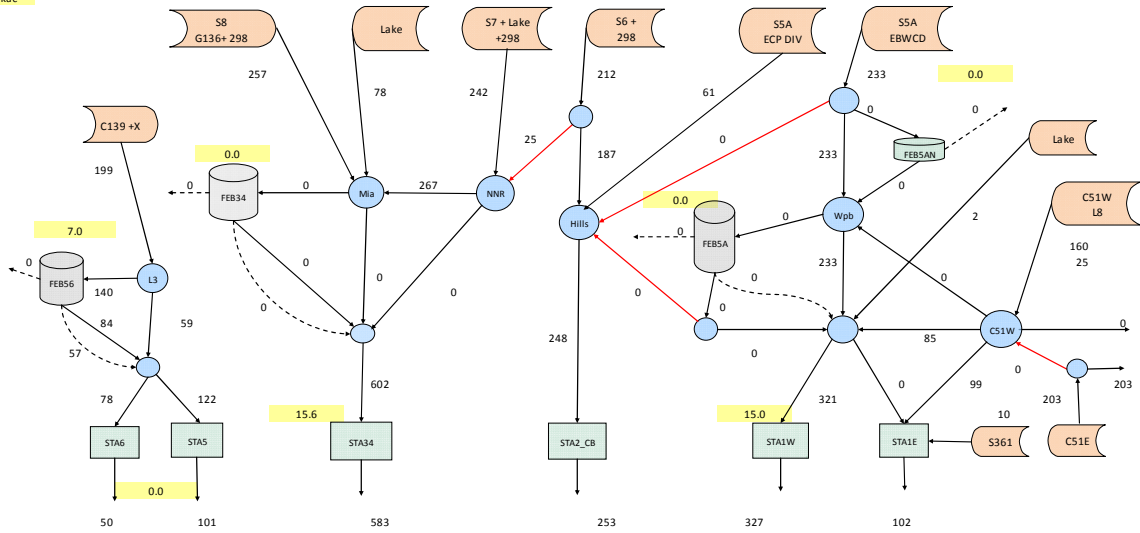

STA Outflow TP ppb	11.5	11.4	11.5	11.5	11.3	11.6	Totals	11.5
STA Expansion kac	0.0	15.6	15.6	15.1	21.7	5.1		30.6
STA Total Area kac	5.1	7.9	32.1	253	327	102		87.1
STA Outflow kac/yr	50	101	583	253	327	102		1416
WCA Inflow kacft		734		253	429			1416

Inputs for Scenario Base_11_5 11.5 ppb Designs, 12 ft FEB in WB, STA Expansion in Other Basins

Diversion Rules				Mass Balance Summary				Base_11_5				project_base_11_5.xls				Run Date	
Diversion	Default	Diverted to	Fraction	Qmax	Description	Area	Flow	Load	Conc	Flow	Load	Conc	Flow	Load	Conc	HLR	HLR Max
C51E Diversion	C51W Canal	EAST	0	1000		STA	kac-ft	mt	ppb	kac-ft	mt	ppb	kac-ft	mt	ppb	cm/d	cm/d
SSA Div (ECART)	SSA Div	HILLS_C	0	800	divert to hills	STA1E	5.1	109	20.4	152	102	1.5	11.6	1.77	7.1		
SSA Div (ECART)	SSA Div	HILLS_C	0	200	low-flow bypass to WPB	STA1W	21.7	321	78.9	199	327	4.6	11.3	1.24	7.0		
SSA Div to FEB	FEBSSA	FEBSSA_N	0		northern STA.FEB	STA2B	15.1	248	46.1	151	253	3.6	11.5	1.37	6.9		
FEB SSA Outflow	STALDW	HILLS_C	0		diversion to Hills	STA34	32.1	602	91.6	123	583	8.3	11.5	1.56	6.6		
C51W Outflow	EAST	STA1E	0.56	600	direct to STA1E	STA5	7.9	122	24.3	161	101	1.4	11.4	1.29	3.7		
C51W Outflow	EAST	STA1_DW	1		direct to STALDW	STA6	5.1	78	15.5	161	50	0.7	11.5	1.27	3.7		
C51W Outflow	EAST	FEB_SSA	1		remainder to East	Total STA	87.1	1479	276.7	152	1416	20.0	11.5	1.42			
STA1W Distrib	STA1W	STA1E	0		WPB C STA1E												
S6 Runoff	STA2CB	NNRC	0.12		S6 divert to NNR												
NNR Canal	FEB34	STA34	0	100	NNR LowQ Bypass to STA34												
STA56 Distrib	STA5	STA6	0.39		Balance STA56 Loads, Hint=	0.394											

FEB Calculations				Input Time Series				Treated Inflow				Outflows				
Parameter	FEB_S5A	FEB_34	FEB_56	FEBSSA_N	Flow	Load	Conc	Flow	Flow CV	Flow Max	Flow	Flow CV	Flow Max	Depth cm	Mean	Min
DMSTA calibration	RES_3	RES_3	RES_3	RES_3	kac-ft	mt	ppb	cfs	-	cfs	kac-ft	-	cfs			
Area kac	7	7	7	7	233.0	61.7	214	322	1.87	4621	0	1.38	2679			
HRT days	60	30	90	30	87.8	17.2	158	121	1.38	2679	0	1.38	2679			
Bypass Depth ft	44	12	12	4	0.0	0.0	0	0	#N/A	0	0	0	0			
LowQ Bypass cfs	100	100	100	200	108.9	20.4	152	150	0.89	644	0	1.93	3531			
Max Qin cfs	2000	4000	2500	1000	247.7	46.1	151	342	1.93	3531	0	1.93	3531			
Max Qout cfs	1000	500	500	100	0.0	0.0	0	0	#N/A	0	0	0	0			
Control Depth ft	0.5	0.5	0.5	0.5	602.3	91.6	123	831	1.79	8698	0	1.20	4647			
Min Release Depth ft	0.5	0.5	0.5	0.5	198.8	53.8	219	274	1.20	4647	0	0.00	0			
Regulation Schedule					1478.5	290.7	159	0	0.00	0	0	0.00	0			
STA WS Release	STA1WX	STA34X	STA56X													
Farm WS Release	15	15.6	0													
Farm Irrig kac	0.67	0.67	0.4													
	SAV_3	SAV_3	PEW_3													

Base Period for Concs					
Use Lake P Concs	TRUE	1= 2005-2009, 2 = 1995-2009			
C139 Load Reduc	0%	for S354 & S351 Lake Releases			
STA Duty Cycle	0.95	Max TP ppb	0		
Target Conc ppb	11.5	New Lake Rel ka	0		
Output Interval Days	30	Iterations	1	use iter=1 for testing, 2 for final	
SSA Load Reduc	0%	Other			
Other		Other			

Watershed Areas					
Scale_s5A	133	Fraction	1	New STA kac	15.0
Scale_s6	105		1	FEB kac	0.0
Scale_s7	120		1	Runoff Rescale	0.89
Scale_s8	120		0		1.00
Scale_Annex	18		1		0.87
					1.00
					0.61

Scenario: 5 A/B - Interim Plan with Temporary A1 FEB & Balance STA-34 Inflow Mean Flow kac-ft/yr

STA Expansion kac

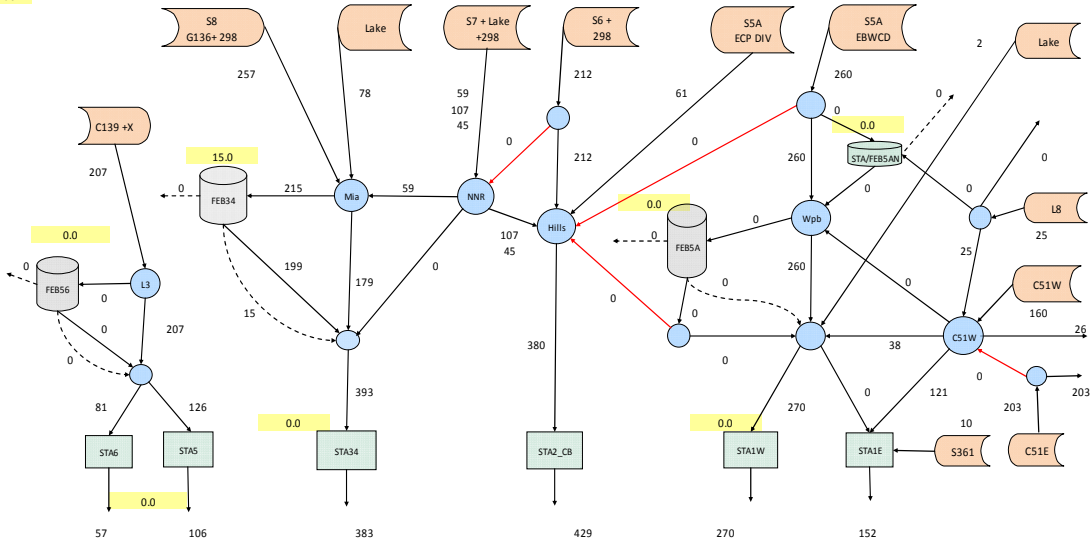

STA Outflow TP ppb	18.3	18.3	11.2	18.2	38.3	20.5	Totals	20.4
STA Expansion kac	0.0	0.0	0.0	0.0	0.0	0.0		0.0
STA Total Area kac	5.1	7.9	16.5	15.1	6.7	5.1		56.5
STA Outflow kac/yr	57	106	383	429	270	152		1397
WCA Inflow kacft			546	429		422		1397

Inputs for Scenario Base_A1_FEB Interim Plan: A1 as FEB, No Additional STA in Central Basin

Diversion Rules				Mass Balance Summary										Run Date		
Diversion	Default	Diverted to	Fraction	Qmax	Description	Area	Inflows	Load	Conc	Outflows	Load	Conc	HLR	HLR Max		
CS1E Diversion	CS1W Canal	EAST	0	1000		kac	Flow	mt	ppb	Flow	mt	ppb	cm/d	cm/d		
SSA Div (ECART)	SSA Div	HILLS_C	0		divert to hills up to qmax	STA	kac-ft			kac-ft						
SSA Div (ECART)	SSA Div	HILLS_C	0		low-flow bypass to WPB	STA1E	5.1	161	32.2	152	3.8	20.5	2.61	9.7		
SSA Div to FEB North	FEBSSA	FEBSSA_N	0		northern STA.FEB	STA1W	6.7	270	68.0	204	12.8	38.3	3.38	20.6		
FEB SSA Outflow	HILLS_C	STA1DW	0		diversion to Hills	STA2B	15.1	425	72.6	139	429	9.6	18.2	2.34		
CS1W Outflow	EAST	STA1E	0.7	600	direct to STA1E	STA34	16.5	393	47.6	98	383	5.3	11.2	1.98		
CS1W Outflow	EAST	STA1_DW	0.6	1200	direct to STA1DW	STA5	7.9	126	33.4	214	106	2.4	18.3	1.34		
CS1W Outflow	EAST	FEB_SSA	0		remainder to East	STA6	5.1	81	21.4	214	57	1.3	18.3	1.32		
STA1W Distrib	STA1W	STA1E	0.1		WPB C STA1E	Total STA	56.5	1455	275.2	153	1397	35.2	20.4	2.15		
S6 Runoff	STA2CB	NNRC	0		S6 divert to NNR											
NNR Canal	FEB34	STA34	0		NNR LowQ Bypass to STA34					STA1W+E	422.1	16.6	31.9			
STA56 Distrib	STA5	STA6	0.39		Balance STA56 Loads, Hlm=	0.394				STA2+34+B	812.3	14.9	14.9			
L8 to STA1N	CS1W	FEBSSA_N	0		To FEB SSAN (Rest to CS1W)					STA5+6	163.1	3.7	18.3			
L8 to North	CS1W	North	0		CEBP											
NNR to CB	STA34	Comp B	1		Original Design for Comp B=1											
NNR to CB 2	STA34	Comp B	0.49		Additional NNR Diversion to CB											

FEB Calculations		DMSTA calibration				Area				Treated Inflow				Outflows			
Parameter	FEB_SSA	FEB_34	FEB_S6	FEBSSA_N	FEBs	Area	Flow	Load	Conc	Flow	Load	Conc	Flow	Load	Conc	Depth cm	
DMSTA calibration	RES_3	RES_3	RES_3	EMG_3	FEBSSA_N	0.0	0.0	0.0	#N/A	0	0.0	#N/A	0	0.0	#N/A	0	0
Area kac	15	15	15		FEB_SSA	0.0	0	0.0	#N/A	0	0.0	#N/A	0	0.0	#N/A	0	0
HRT days	30	14	90	30	FEB_34	15.0	215	29.6	112	199	15.7	64	44	1			
Bypass Depth ft	44	4	12	4	FEB_S6	0.0	0	0.0	108	0	0.0	#N/A	0	0			
LowQ Bypass cfs	200	400	100	100	Total FEB	15.0	215	29.6	112	199	15.7	64	44	1			
Max Qin cfs	2000	2775	2500	2000													
Max Qout cfs	1000	1000	500	500													
Control Depth ft	0.5	0.5	0.5	0.5													
Min Release Depth ft	0.5	0.5	0.5	0.5													
Regulation Schedule	FEB_REG	FEB_REG	FEB_REG		Optional:												
STA WS Release	REL_STA	REL_STA	REL_STA		See FEB Design Sheet	Input Time Series	Flow	Load	Conc	Flow	Flow CV	Flow Max					
Farm WS Release	REL_URB+FARM			REL_FARM	See input series sheet	TS_FEBSSA_N	0.0	0.0	0	0	#N/A	0					
Frac Irrig Demand	0.5			0.25		TS_FEBSSA	259.5	67.7	211	358	1.87	5153					
Frac CS1 Urban WS	1					TS_STA1DW	40.6	7.9	157	56	1.74	1200					
STA Expansion	STA1WX	STA34X	STA56X			TS_STA1W	0.0	0.0	0	0	#N/A	0					
Area kac	0	0	0			TS_STA1E	130.5	24.6	153	180	0.85	644					
Fraction SAV	0.67	0.67	0.4			TS_STA2B	424.6	72.6	139	586	2.00	6153					
Enhanced	SAV_3	SAV_3	PEW_3			TS_FEB34	393.8	60.4	124	544	1.73	5579					
						TS_STA34	0.0	0.0	0	0	#N/A	0					
						TS_FEB56	207.1	54.8	214	286	1.20	4806					
						Total	1456.2	287.9	160	0	0.00	0					

Base Period for Concs		Use Lake P Concs				C139 Load Reduc		STA Duty Cycle		Target Conc ppb		Output Interval		SSA Load Reduc		Other	
Parameter	Value	1=2005-2009,2=1995-2009	3=2005-2009,4=1995-2009	5=2005-2009,6=1995-2009	7=2005-2009,8=1995-2009	9=2005-2009,10=1995-2009	11=2005-2009,12=1995-2009	13=2005-2009,14=1995-2009	15=2005-2009,16=1995-2009	17=2005-2009,18=1995-2009	19=2005-2009,20=1995-2009	21=2005-2009,22=1995-2009	23=2005-2009,24=1995-2009	25=2005-2009,26=1995-2009	27=2005-2009,28=1995-2009	29=2005-2009,30=1995-2009	31=2005-2009,32=1995-2009
Base Period for Concs	1																
Use Lake P Concs	TRUE																
C139 Load Reduc	0%																
STA Duty Cycle	0.95																
Target Conc ppb	11.5																
Output Interval	30																
SSA Load Reduc	0%																
Other																	

Watershed Areas		Land kac		Fraction		New STA kac		FEB kac		Runoff Rescale	
Area	Value	Value	Value	Value	Value	Value	Value	Value	Value	Value	Value
Scale_s5A	133	1	0.0	0.0	1.00						
Scale_s6	105	1			1.00						
Scale_s7	120	1	15.0	15.0	0.75						
Scale_s8	120	0			1.00						
Scale_Annex	18	1	0.0	0.0	1.00						

Scenario: 6 C - C51E Diversion /FEB, STA Expansion

Mean Flow kac-ft/yr

STA Expansion kac

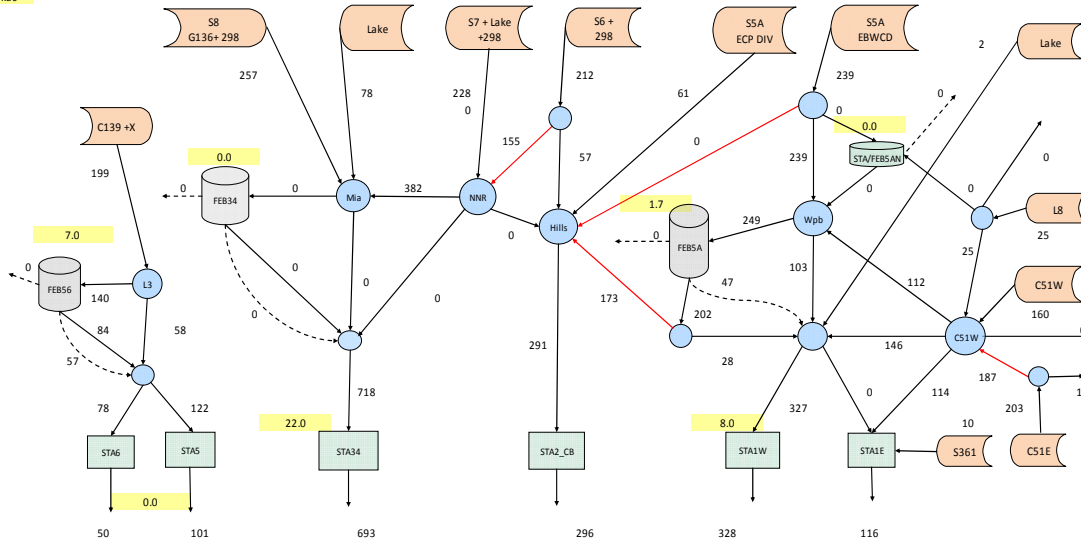

STA Outflow TP	ppb	11.5	11.4	11.5	11.5	11.5	11.5	Totals	11.5
STA Expansion	kac	0.0		22.0		8.0			30.0
STA Total Area	kac	5.1	7.9	38.5	15.1	14.7	5.1		86.5
STA Outflow kac/yr		50	101	693	296	328	116		1584
WCA Inflow	kacft			844	296		444		1584

Inputs for Scenario C51E_AA C51E Diversion, STA exp in CB, FEB in C139

Diversion Rules		Mass Balance Summary		C51E_AA		project_c51e_aa.xls		Run Date	
Default	Diverted to	Fraction	Qmax	Description	Inflow	Load	Conc	Flow	Load
C51W Canal	EAST	1	1000		kac	kac-ft	mt	kac-ft	mt
SSA Div (ECART)	HILLS_C	0	300	divert to hills up to qmax	5.1	123	18.7	123	116
SSA Div (ECART)	HILLS_C	0	200	low-flow bypass to WPB	14.7	327	63.2	157	328
SSA Div to FEB North	FEBSSA_N	0		northern STA.FEB	15.1	291	64.0	178	296
FEB SSA Outflow	HILLS_C	1	75	diversion to Hills	38.5	718	110.3	125	693
C51W Outflow	EAST	0.31	600	direct to STA1E	7.9	122	24.2	161	101
C51W Outflow	EAST	1	300	direct to STA1DW	5.1	78	15.5	161	50
C51W Outflow	EAST	1	0	remainder to East	86.5	1659	296.0	145	1584
STA1W Distrib	STA1E	0		WPB C STA1E				22.5	11.5
S6 Runoff	STA2CB	0.73		S6 divert to NNR				444.0	6.3
NNR Canal	FEB34	0		NNR LowQ Bypass to STA34				989.4	14.0
STA56 Distrib	STA5	0.39		Balance STA56 Loads, Hint=				150.9	2.1
L8 to STA1N	C51W	0		To FEB SSAN (Rest to C51W)					
L8 to North	C51W	0		CERP					
NNR to CB	STA34	0		Original Design for Comp B =1					

FEB Calculations	FEB_SSA	FEB_34	FEB_56	FEBSSA_N	FEBs	Area	Flow	Load	Conc	Flow	Load	Conc	Depth
DMSTA calibration	RES_3	RES_3	RES_3	EMG_3	FEBSSA_N	0.0	0	0.0	#N/A	0	0.0	#N/A	0
Area kac	1.67	7			FEB_SSA	1.7	249	57.7	188	202	45.1	181	561
HRT days	30	14	90	30	FEB_34	0.0	0	0.0	#N/A	0	0.0	#N/A	0
Bypass Depth ft	44	4	12	4	FEB_56	7.0	140	40.0	231	84	15.7	151	153
LowQ Bypass cfs	200	400	100	100	Total FEB	1.7	249	57.7	188	202	45.1	181	
Max Qin cfs	2000	4000	2500	2000									
Max Qout cfs	1000	1000	500	500									
Control Depth ft	0.5	0.5	0.5	0.5									
Min Release Depth ft	0.5	0.5	0.5	0.5									

Regulation Schedule	FEB_REG	FEB_REG	FEB_REG	Optional:	Input Time Series	Flow	Load	Conc	Flow	Flow CV	Flow Max
STA WS Release	URB+STA+REF	REL_STA	REL_STA	See FEB_Design Sheet	TS_FEBSSA_N	0.0	0.0	0	0	#N/A	0
Farm WS Release				See input series sheet	TS_FEBSSA	351.5	80.9	186	485	1.67	8130
Frac Irrig Demand	0.5				TS_STA1DW	148.5	23.2	127	205	0.49	829
Frac C51 Urban WS	1				TS_STA1W	0.0	0.0	0	0	#N/A	0
STA Expansion	STA1WX	STA34X	STA56X		TS_STA1E	123.3	18.7	123	170	0.88	644
Area kac	8	22	0		TS_STA2B	118.3	25.2	173	163	1.80	1499
Fraction SAV	0.67	0.67	0.4		TS_FEB34	0.0	0.0	0	0	#N/A	0
Enhanced	SAV_3	SAV_3	PEW_3		TS_STA34	717.7	110.3	125	991	1.82	10491
Base Period for Concs	1	1= 2005-2009, 2 = 1995-2009			TS_FEB56	198.8	53.8	219	274	1.20	4647
Use Lake P Concs	TRUE	for S354 & S351 Lake Releases			Total	1658.0	312.1	153	0	0.00	0
C139 Load Reduc	0%	Max TP ppb	0								
STA Duty Cycle	0.95	New Lake Rel ka	0								
Target Conc ppb	11.5	Iterations	1	use iter=1 for testing, 2 for final							
Output Interval	30	SSA/C51 Cmax	0								
SSA Load Reduc	0%	S678 Cmax	0								
Refuge Min Flow	500	C139 Cmax	0	See FEB_STA Sheet, Provision to direct more flow to refuge in dry years.							

Watershed Areas	Land kac	Fraction	New STA kac	FEB kac	Runoff Rescale
Scale_s5A	133	1	9.7	1.7	0.91
Scale_s6	105	1			1.00
Scale_s7	120	1	22.0	0.0	0.82
Scale_s8	120	0			1.00
Scale_Annex	18	1	0.0	7.0	0.61

Scenario: 7 D - C51E Diversion/FEB, A2 FEB+STA, A1 STA

Mean Flow kac-ft/yr

STA Expansion kac

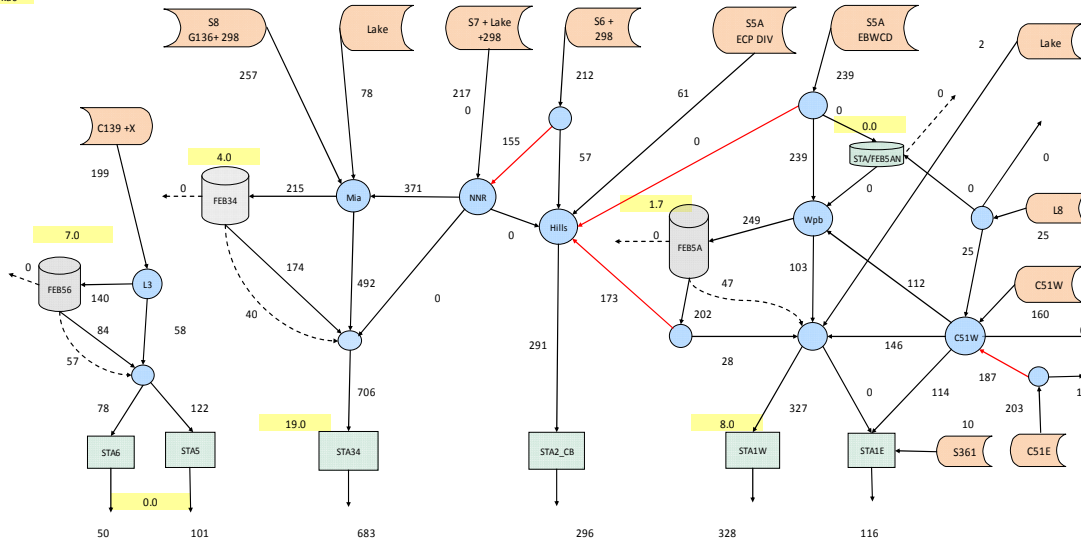

STA Outflow TP ppb	11.5	11.4	11.5	11.5	11.5	11.5	Totals	11.5
STA Expansion kac	0.0	7.9	19.0	15.1	8.0	5.1		27.0
STA Total Area kac	5.1	7.9	35.5	15.1	14.7	5.1		83.5
STA Outflow kac/yr	50	101	683	296	328	116		1574
WCA Inflow kacft			834	296		444		1574

Inputs for Scenario C51E_A1_RES_3 C51E Div + FEB, A2 8 ft FEB + STA Exp, A1 STA, C139 12 ft FEB

Diversion Rules		Mass Balance Summary				C51E_A1_RES_3_project_c51e_a1_res_3.xls						Run Date		9/1/10 21:15	
Diversion	Default	Diverted to	Fraction	Qmax	Description	Area	Inflows	Load	Conc	Flow	Load	Conc	HLR	HLR Ma	
C51E Diversion	C51W Canal	EAST	1	1000		kac	Flow	mt	ppb	Flow	mt	ppb	cm/d	cm/d	
SSA Div (ECART)	SSA Div	HILLS_C	0	300	divert to hills up to qmax	STA	kac-ft			kac-ft					
SSA Div (ECART)	SSA Div	HILLS_C	0	200	low-flow bypass to WPB	STA1E	5.1	123	18.7	123	116	1.6	11.5	2.00	
SSA Div to FEB North	FEBSSA	FEBSSA_N	0	0	northern STA.FEB	STA1W	14.7	327	63.2	157	328	4.7	11.5	1.86	
FEB SSA Outflow	HILLS_C	STA1DW	1	75	diversion to Hills	STA2B	15.1	291	64.0	178	296	4.2	11.5	1.61	
C51W Outflow	EAST	STA1E	0.31	600	direct to STA1E	STA34	35.5	706	103.1	118	683	9.7	11.5	1.66	
C51W Outflow	EAST	STA1_DW	1	300	direct to STA1DW	STA5	7.9	122	24.3	162	101	1.4	11.4	1.29	
C51W Outflow	EAST	FEB_S5A	1	0	remainder to East	STA6	5.1	78	15.5	162	50	0.7	11.5	1.27	
STA1W Distrib	STA1W	STA1E	0	0	WPB C STA1E	Total STA	83.5	1647	288.8	142	1574	22.4	11.5	1.65	
S6 Runoff	STA2CB	NNRC	0.73	0	S6 divert to NNR										
NNR Canal	FEB34	STA34	0	0	NNR LowQ Bypass to STA34					STA1W+E	444.0	6.3	11.5		
STA56 Distrib	STA5	STA6	0.39	0	Balance STA56 Loads, Hint= 0.394					STA2+34+B	979.4	13.9	11.5		
L8 to STA1N	C51W	FEBSSA_N	0	0	To FEB SSAN (Rest to C51W)					STA5+6	150.9	2.1	11.5		
L8 to North	C51W	North	0	0	CERP										
NNR to CB	STA34	Comp B	0	0	Original Design for Comp B =1										

FEB Calculations	FEB_S5A	FEB_34	FEB_56	FEBSSA_N	FEBs	Area	Flow	Load	Conc	Flow	Load	Conc	Depth cm
DMSTA calibration	RES_3	RES_3	RES_3	EMG_3	FEBSSA_N	kac	kac-ft	mt	ppb	kac-ft	mt	ppb	Mean
Area kac	1.67	4	7		FEB_S5A	0.0	0	0.0	#N/A	0	0.0	#N/A	0
HRT days	30	30	90	30	FEB_34	1.7	249	57.7	188	202	45.1	181	561
Bypass Depth ft	44	9	12	4	FEB_56	4.0	215	32.4	122	174	21.6	101	163
LowQ Bypass cfs	200	400	100	100	Total FEB	7.0	140	40.0	231	84	15.7	151	155
Max Qin cfs	2000	2500	2500	2000		5.7	463	90.1	158	376	66.7	144	
Max Qout cfs	1000	1000	500	500									
Control Depth ft	0.5	0.5	0.5	0.5									
Min Release Depth ft	0.5	0.5	0.5	0.5									
Regulation Schedule	FEB_REG	FEB_REG	FEB_REG		Optional:								
STA WS Release	URB+STA+REF	REL_STA	REL_STA		See FEB_Design Sheet	Input Time Series	Flow	Load	Conc	Flow	Flow CV	Flow Max	
Farm WS Release				REL_FARM	See input series sheet	TS_FEBSSA_N	kac-ft	mt	ppb	cfs	-	cfs	
Frac Irrig Demand	0.5			0.25		TS_FEBSSA	0.0	0.0	0	0	#N/A	0	
Frac C51 Urban WS	1					TS_STA1DW	351.5	80.9	186	485	1.67	8130	
STA Expansion	STA1WX	STA34X	STA56X			TS_STA1W	148.5	23.2	127	205	0.49	829	
Area kac	8	19	0			TS_STA1E	0.0	0.0	0	0	#N/A	0	
Fraction SAV	0.67	0.67	0.4			TS_STA1E	123.3	18.7	123	170	0.88	644	
Enhanced	SAV_3	SAV_3	PEW_3			TS_STA2B	118.3	25.2	173	163	1.80	1499	
						TS_FEB34	706.7	108.7	125	976	1.81	10310	
						TS_STA34	0.0	0.0	0	0	#N/A	0	
						TS_FEB56	198.8	53.8	219	274	1.20	4647	
						Total	1647.1	310.5	153	0	0.00	0	

Base Period for Concs	1	1= 2005-2009,2 = 1995-2009			
Use Lake P Concs	TRUE	for S354 & S351 Lake Releases			
C139 Load Reduc	0%	Max TP ppb	0		
STA Duty Cycle	0.95	New Lake Rel ka	0		
Target Conc ppb	11.5	Iterations	1	use iter=1 for testing, 2 for final	
Output Interval	30	SSA/C51 Cmax	0		
SSA Load Reduc	0%	S678 Cmax	0		
Refuge Min Flow	500	C139 Cmax	0	See FEB_STA Sheet, Provision to direct more flow to refuge in dry years.	

Watershed Areas	Land kac	Fraction	New STA kac	FEB kac	Runoff Rescale
Scale_s5A	133	1	9.7	1.7	0.91
Scale_s6	105	1			1.00
Scale_s7	120	1	23.0	4.0	0.78
Scale_s8	120	0			1.00
Scale_Annex	18	1	0.0	7.0	0.61

Scenario: 8 C/D - Interim Plan with Temporary A1 FEB, Balance STA-34 Inflow, C51E Div/FEB Mean Flow kac-ft/yr

STA Expansion kac

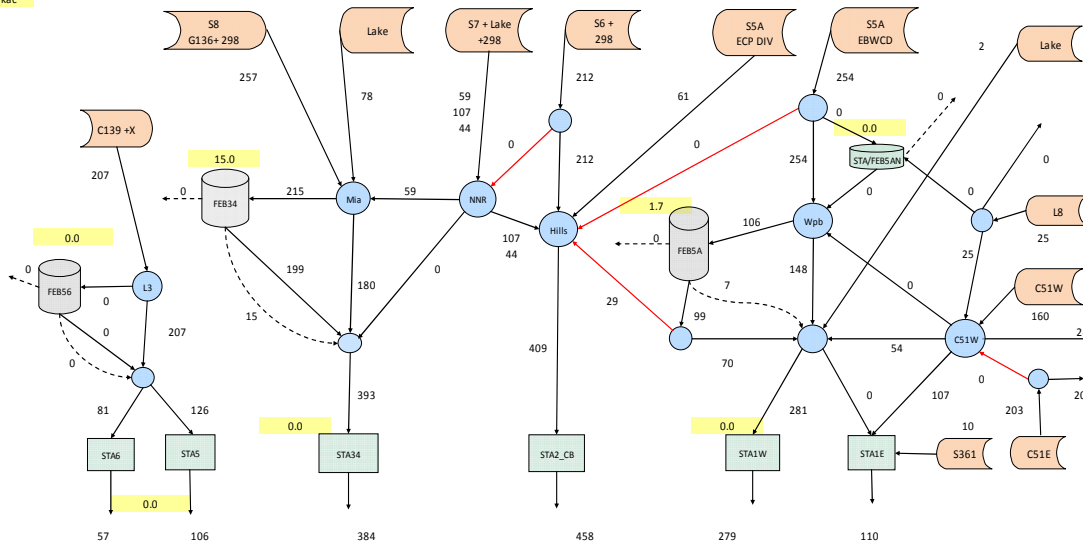

STA Outflow TP	ppb	18.3	18.3	11.3	19.2	37.3	12.9	Totals	20.0
STA Expansion	kac	0.0	0.0	0.0	0.0	0.0	0.0		0.0
STA Total Area	kac	5.1	7.9	16.5	15.1	6.7	5.1		56.5
STA Outflow	kac/yr	57	106	384	458	279	110		1393
WCA Inflow	kacft		547		458		389		1393

Inputs for Scenario C51E_Interim Phase 1 - A1 as 4 ft FEB, C51 Rockpit 10 kacft (6/44 ft), 3 yrs, No STA expansion; Partial Diversion to West

Diversion Rules		Mass Balance Summary										Run Date	8/31/10 20:26	
Diversion	Default	Diverted to	Fraction	Qmax	Description	Area	Inflows	Load	Conc	Outflows	Load	Conc	HLR	HUR Ma
						kac	Flow	mt	ppb	Flow	mt	ppb	cm/d	cm/d
C51E Diversion	C51W Canal	EAST	0	1000										
SSA Div (ECART)	SSA Div	HILLS_C	0		divert to hills up to qmax	STA1E	5.1	117	21.9	152	110	1.7	12.9	1.90
SSA Div (ECART)	SSA Div	HILLS_C	0		low-flow bypass to WPB	STA1E	5.1	117	21.9	152	110	1.7	12.9	1.90
SSA Div to FEB North	FEBSSA	FEBSSA_N	0		northern STA.FEB	STA1W	6.7	281	66.0	190	279	12.8	37.3	3.51
FEB SSA Outflow	HILLS_C	STA1DW	1	200	diversion to Hills	STA2B	15.1	453	78.7	141	458	10.9	19.2	2.50
C51W Outflow	EAST	STA1E	0.6	700	direct to STA1E	STA34	16.5	393	47.8	98	384	5.3	11.3	1.98
C51W Outflow	EAST	STA1_DW	0.7	1000	direct to STA1DW	STA5	7.9	126	33.4	214	106	2.4	18.3	1.34
C51W Outflow	EAST	FEB_S5A	0		remainder to East	STA6	5.1	81	21.4	214	57	1.3	18.3	1.32
STA1W Distrib	STA1W	STA1E	0		WPB C STA1E	WPB C STA1E	56.5	1451	269.1	150	1393	34.4	20.0	2.14
S6 Runoff	STA2CB	NNRC	0		S6 divert to NNR	Total STA	56.5	1451	269.1	150	1393	34.4	20.0	2.14
NNR Canal	FEB34	STA34	0		NNR LowQ Bypass to STA34					STA1W+E	388.6	14.6	30.4	
STA56 Distrib	STA6	STA6	0.39		Balance STA56 Loads, Hint-	0.394				STA2+34+B	841.3	16.2	15.6	
L8 to STA1N	C51W	FEBSSA_N	0		To FEB SSAN (Rest to C51W)					STA5+6	163.1	3.7	18.3	
L8 to North	C51W	North	0		CERP									
NNR to CB	STA34	Comp B	1		Original Design for Comp B-1									
NNR to CB 2	STA34	Comp B	0.48		Additional NNR Diversion to CB									

FEB Calculations	FEB_S5A	FEB_34	FEB_S6	FEBSSA_N	FEBs	Area	Inflows	Load	Conc	Outflows	Load	Conc	Depth cm	Mean	Min
	RES_3	RES_3	RES_3	EMG_3	FEBSSA_N	kac	Flow	mt	ppb	Flow	mt	ppb	cm	cm	cm
DMSTA calibration	1.7	15	0		FEBSSA_N	0.0	0.0	0.0	#N/A	0	0.0	#N/A	0	0	0
Area kac	1.7	15	0		FEB_S5A	1.7	106	27.5	210	99	20.9	171	108	5	5
HRT days	14	14	90	30	FEB_34	15.0	215	29.7	112	199	15.7	64	45	1	1
Bypass Depth ft	5.9	4	12	4	FEB_S6	0.0	0	0.0	68	0	0.0	#N/A	0	0	0
LowQ Bypass cfs	200	400	50	100	Total FEB	16.7	321	57.2	144	298	36.6	99			
Max Qin cfs	2000	2775	2500	2000											
Max Qout cfs	1000	1000	500	500											
Control Depth ft	0.5	0.5	0.5	0.5											
Min Release Depth ft	0.5	0.5	0.5	0.5											

Regulation Schedule	FEB_REG	FEB_REG	FEB_REG	Optional:	Input Time Series	Flow	Load	Conc	Flow	Flow CV	Flow Max
STA WS Release	REL_STA	REL_STA	REL_STA	See FEB_Design Sheet	TS_FEBSSA_N	kac-ft	mt	ppb	cfs	-	cfs
				See input series sheet	TS_FEBSSA						
Farm WS Release				REL_FARM	TS_STA1DW	56.3	10.9	157	78	1.34	1000
Frac Irrig Demand	0.5			0.25	TS_STA1W	0.0	0.0	0	0	#N/A	0
Frac C51 Urban WS	1				TS_STA1E	116.8	21.9	152	161	0.91	744
STA Expansion	STA1WX	STA34X	STA56X		TS_STA2B	423.7	72.5	139	585	2.00	6132
Area kac	0	0	0		TS_FEB34	394.7	60.5	124	545	1.73	5600
Fraction SAV	0.67	0.67	0.4		TS_STA34	0.0	0.0	0	0	#N/A	0
Enhanced	SAV_3	SAV_3	PEW_3		TS_FEB56	207.1	54.8	214	286	1.20	4806
					Total	1452.2	286.9	160	0	0.00	0

Base Period for Concs	1	1= 2005-2009, 2= 1995-2009	FEB kac	Runoff Rescale
Use Lake P Concs	TRUE	for S354 & S351 Lake Releases	1.7	1.00
C139 Load Reduc	0%	Max TP ppb	0	1.00
STA Duty Cycle	0.95	New Lake Rel ka	0	0.75
Target Conc ppb	11.5	Iterations	1	1.00
Output Interval	30	SSA/C51 Cmax	0	1.00
SSA Load Reduc	0%	S678 Cmax	0	1.00
Other		C139 Cmax	0	

Watershed Areas	Land kac	Fraction	New STA kac	FEB kac	Runoff Rescale
Scale_s5A	133	1	1.7	1.7	1.00
Scale_s6	105	1			1.00
Scale_s7	120	1	15.0	15.0	0.75
Scale_s8	120	0			1.00
Scale_Annex	18	1	0.0	0.0	1.00

1 February 16, 2010

2 Modeling Phosphorus Dynamics in Everglades Wetlands and
3 Stormwater Treatment Areas

4
5 William W. Walker, Jr. ¹ and Robert H. Kadlec²

6 ¹Environmental Engineer, Concord, Massachusetts, bill@wwwalker.net

7 ²Wetland Management Services, Chelsea, Michigan, rhkadlec@chartermi.net,

8
9 Submitted to

10 Based on Presentation at GEER 2008 Symposium

11 **Abstract**

12
13 Longitudinal gradients in phosphorus (P) stored in the water column, vegetation, and
14 soils develop in the wetlands where inflow P concentrations exceed background levels.
15 Prior to the mid 1990's, the Everglades regional P gradient ranged from 100-200 $\mu\text{g L}^{-1}$
16 in marsh inflows to background levels of 4-8 $\mu\text{g L}^{-1}$. Subsequent implementation of P
17 controls, including agricultural Best Management Practices (BMPs) and Stormwater
18 Treatment Areas (STAs), reduced the average inflow concentration along the northern
19 edge of the Water Conservations Areas (WCAs) to approximately 33 $\mu\text{g L}^{-1}$ in 2007-
20 2009. Additional P controls are being implemented and further measures beyond those
21 currently planned will be required to restore the entire marsh. This paper describes the
22 evolution and application of relatively simple mass-balance models to simulate P storage
23 and cycling processes along P gradients in the STAs and downstream marsh. The models
24 are practical engineering tools that have been extensively applied to the design of
25 Everglades regional P control plans involving combinations of source controls, water
26 management, reservoirs, and STAs, as well as in simulating P dynamics in natural
27 marshes immediately downstream of treated and untreated discharges.

28 **Key Words**

29 Everglades, phosphorus, modeling, marsh, engineering, wetland treatment areas
30

31 **Introduction**

32

33 As water with elevated phosphorus (P) moves through a wetland ecosystem, P is removed
34 and a gradient of decreasing P concentration is produced along the flow path (Reddy et
35 al., 1993; Craft et al., 1993a; Craft et al, 1993b; Walker, 1995; Kadlec & Walker, 1999).

36 The water-column P gradient is typically accompanied by gradients of P storage in
37 vegetation and soils (Figure 1). Phosphorus originating in inflows and atmospheric
38 deposition is cycled within the marsh and ultimately stored in accreting peat or
39 transported downstream. Historically, the water-column P gradient in the Everglades
40 marsh ranged from 100-200 $\mu\text{g L}^{-1}$ at the inflows to background levels of 4-8 $\mu\text{g L}^{-1}$
41 (Figure 2). Nearly two decades of monitoring and research by the South Florida Water
42 Management District (SFWMD) and other agencies have established that Everglades
43 wetland ecosystems change dramatically along the P gradient and that native slough and
44 sawgrass communities are viable only at P concentrations below 10 $\mu\text{g L}^{-1}$, expressed as a
45 long-term geometric mean (Payne et al, 2003). With sheet flow hydraulics, water quality
46 at the edge of the marsh is determined by the quality of the inflows. Restoring and
47 protecting the entire marsh is likely to require inflow P concentrations equivalent to the
48 marsh P criterion (Payne et al, 2008). This is in contrast to lakes or other well-mixed
49 water bodies where inflows with concentrations exceeding water quality standards do not
50 trigger violations of ambient standards because they are rapidly dispersed, diluted, and/or
51 assimilated in receiving waters.

52

53 Spatial and temporal variations in the Everglades regional P gradient over the past three
54 decades are shown in Figure 2. Substantial progress has been made since 1993 in
55 reducing P concentrations in the inflows to the Water Conservation Areas (WCAs)
56 through implementation of agricultural Best Management Practices (BMPs) and
57 construction of Stormwater Treatment Areas (STAs) (SFWMD, 2009b). As these control

58 measures were implemented, the combined WCA inflow concentration decreased from
59 $\sim 170 \mu\text{g L}^{-1}$ in 1980-1989 to $\sim 61 \mu\text{g L}^{-1}$ in 2000-2009. Within the last decade, the three-
60 year rolling-average inflow concentration decreased from $\sim 64 \mu\text{g L}^{-1}$ in 2001-2004 to
61 $\sim 33 \mu\text{g L}^{-1}$ in 2007-2009. The historical reductions in inflow concentration have
62 cascaded through the networks of canals and marshes to cause P concentration reductions
63 in the outflows from each WCA (Figure 2). Further reductions in WCA inflow and
64 outflow concentrations are expected to result from implementation of additional source-
65 control and treatment measures.

66
67 The effect of the P control program is to displace the P gradient upstream of the marsh so
68 that most of it occurs within STAs constructed on formerly agricultural land (Figure 1).
69 At the same time, elevated P concentrations driving the gradient are reduced through
70 implementation of BMPs. When long-term restoration objectives are achieved, the marsh
71 gradient will be substantially reduced relative to historical conditions and have long-term
72 geometric mean P concentrations ranging from $10 \mu\text{g L}^{-1}$ to background levels of 4-8 μg
73 L^{-1} .

74
75 This paper describes the evolution of relatively simple mass-balance models to simulate P
76 storage and cycling processes along P gradients in the STAs and marsh. In the context
77 of the Everglades restoration effort, the models and associated software have provided
78 practical engineering tools for designing P control measures involving combinations of
79 source controls, regional water management, reservoirs, and STAs, as well as for
80 simulating marsh responses to variations in flow and P load in transects downstream of
81 WCA inflow points.

82

83 **Model Evolution**

84

85 The models described below were developed to support evaluation of multiple STA
86 design alternatives by engineering professionals without requiring site-specific
87 calibration data or specialized expertise in wetland modeling. Model simplicity results

88 from aggregation of key variables and processes controlling phosphorus storage and
89 cycling. The simplifying assumptions are supported by calibration and testing against
90 several dozen datasets that describe phosphorus removal in experimental prototypes,
91 field-scale test cells, full-scale STAs, and natural wetlands (Walker & Kadlec, 2001;
92 2005). These datasets provide bases for calibration and testing under a wide range of
93 conditions (e.g. size, water depth, P concentration, P load, velocity, vegetation types,
94 inflow variability) and for estimating uncertainty associated with model forecasts. While
95 the modeling effort was initiated to support STA design, the fundamental concepts (mass
96 balance, hydraulics, P cycling mechanisms) operating along a P gradient (Figure 1) also
97 apply to natural wetlands. Differences between the STAs and natural marsh related such
98 factors as water depth, hydraulic loads, antecedent soils, and vegetation are considered by
99 explicitly including those factors in the model(s) or by defining limits of application
100 consistent with calibration datasets.

101

102 Figure 3 shows P storage compartments and fluxes associated with four models that
103 evolved over the 1995-2008 period (Kadlec, 1994; Walker, 1995; Walker & Kadlec,
104 1999; Walker & Kadlec, 2005; Kadlec, 2006). They involve different combinations of
105 three fundamental storage compartments (water column, biota, soil) and associated net
106 fluxes between compartments. While P generally moves in both directions between
107 compartments via different mechanisms, the aggregated models simulate the net fluxes
108 that ultimately drive the mass balance. Model structures represent P storage and net
109 fluxes per unit area of marsh. These are coupled with hydraulic models to predict water
110 movement and P transport. Excel spreadsheet software developed to support model
111 applications is limited to relatively simple one-dimensional hydraulic models
112 representing sheet flow along a marsh transect or STAs with individual treatment cells
113 connected in series and/or parallel. The P cycling variables and equations can be
114 translated to more complex hydraulic models capable of predicting two-dimensional flow
115 and mass transport in an STA or marsh. For example, Chen et al (2009) have included
116 DMSTA's P cycling algorithms in a two-dimensional hydraulic model of WCA-1.

117

118 Models with greater complexity have been developed for describing water and
119 phosphorus movement in STAs (Guardo and Tomasello 1995; HydroQual, 1998
120 Moustafa and Hamrick, 2000) and Everglades marsh (Fitz and Trimbel, 2006; Munson et
121 al, 2002; Jawitz et al., 2008). They generally account for two-dimensional spatial and
122 temporal variability and have several state variables and adjustable parameters. Most
123 require enhanced computers, long run times, site-specific calibration data, and special
124 expertise to calibrate and apply. These requirements generally preclude engineering
125 applications to STA design. The Everglades Landscape Model (ELM, Fitz and
126 Trimbel,2006) has been extensively used in the Everglades restoration effort. It simulates
127 system-wide variations in marsh hydrology, water quality, soils, and vegetation in
128 response to variations in marsh inflows and other factors projected to occur in response to
129 long-term restoration efforts. The models described below can be used to evaluate
130 localized impacts of discharges and to provide inflow boundary conditions for ELM
131 applications to the entire Everglades marsh.

132 ***Steady-State STA Design Model (STADM)***

133

134 The STA design model (STADM) (Walker, 1995) was used to develop initial designs for
135 ~29,000 hectares of STAs to achieve a long-term flow-weighted mean outflow
136 concentration of $50 \mu\text{g L}^{-1}$ (Burns and McDonnell, 1994). A modified version that places
137 a lower bound on P concentration (Kadlec, 1994; Kadlec and Wallace, 2009) was used in
138 the initial design of STA-3/4 (Burns and McDonnell, 1999). Knowledge and experience
139 gained through research, operation, and monitoring of these initial STAs subsequently
140 provided a technical basis for optimizing and expanding the STAs to achieve lower P
141 concentrations, as well as for improving the models to support that effort (SFWMD,
142 2009b).

143

144 The STADM simulates the long-term-average water-column P gradient along a marsh
145 transect as a function of the average inflow volume, inflow load, flow-path width, and
146 atmospheric deposition. The model includes one P storage compartment (water column)
147 and three P fluxes: inflow, outflow, and net removal in the accreting peat (Figure 3).

148 hort-term variations in P storage and cycling in vegetation and soils are essentially
149 embedded in the calibration. Because the design objective was expressed as a long-term
150 flow-weighted mean, predictions of short-term variations in P concentration were not
151 required to support the $50 \mu\text{g L}^{-1}$ STA designs. A steady-state model is not sufficient,
152 however, for designing STAs to achieve lower P concentrations driven by highly pulsed
153 inflows (see DMSTA, below)

154

155 The STADM assumes that the average net P removal rate per unit area is proportional to
156 the average water-column concentration. No P removal is assumed to occur when the
157 marsh is nearly dry (water depth < 30 cm). The proportionality constant (“net settling
158 rate” = 10.2 ± 1.4 meters/yr) was calibrated to peat accretion measurements along the P
159 gradient in the WCA-2A marsh downstream of outflows from WCA-1 (Figure 2). The
160 peat data provided an integral measure of net P removal over a 26-year period. Global
161 distribution of fallout from nuclear bomb testing in 1963 placed a layer of radioactive
162 Cesium-127 in the soil profile. The accumulated soil P was estimated by vertically
163 integrating from the peak in Cesium-127 content to the surface using soil cores collected
164 at 24 monitoring sites (Reddy et al., 1991, 1993; Craft and Richardson, 1993ab). The
165 model was tested against limited water-column concentration data along the same marsh
166 transects (Walker, 1995). Because of the limited quantity and the high spatial and
167 temporal variability in the water column data, the integrated peat accretion data provided
168 a preferred basis for calibrating the model to predict long-term P removal rates. Data
169 from wetland treatment areas sufficient to support calibration were not available at the
170 time of STADM development.

171

172 Effects of variability in the inflows, water depth, hydraulics, and vegetation types were
173 embedded in the STADM calibration to the marsh. In applying the model to design the
174 $50 \mu\text{g L}^{-1}$ STAs, it was assumed that STA vegetation types and P cycling processes
175 would be similar to those in the upper portion of the P gradient in the WCA-2A marsh
176 used for calibration (predominantly cattail). Potentials for regulating STA inflow
177 volumes, flow distribution, water depths, and vegetation to optimize treatment suggested
178 that the model calibrated to a natural wetland would generate conservative forecasts of

179 STA performance. Subsequent data from full-scale treatment cells with primarily
180 emergent vegetation indicated an average net settling rate of 11.4 m/yr as compared with
181 the STADM calibrated value of 10.2 m/yr (Walker & Kadlec, 2005). Average net
182 settling rates computed for entire STAs with both emergent and submerged vegetation
183 operated in design ranges have ranged from ~10 to ~25 m/yr.

184

185 ***Everglades Phosphorus Model (EPGM)***

186

187 The Everglades Phosphorus Gradient Model (EPGM) (Walker & Kadlec, 1996;
188 Kadlec & Walker, 1999) tracks P accumulation in soils along marsh transects
189 downstream of inflows with P concentrations above marsh background levels (Figure 1,
190 Figure 3). While not required for STA design, predictions of soil P variations in the
191 marsh are useful because some ecosystem components are driven more by soil P content
192 (cattails, other rooted vegetation) than by water-column concentration (periphyton, algae,
193 invertebrates). There is substantially greater uncertainty associated with modeling the
194 soil P compartment, as compared with modeling the water column. This uncertainty
195 reflects inherent complexities of soil interactions with vegetation and water column, as
196 well as limitations in soils data related to sampling artifacts and high spatial variability
197 (Grunwald et al., 2004; Cohen et al., 2009). EPGM provides the simplest representation
198 of the soil P compartment consistent with the data available for calibration.

199

200 The water-column component of EPGM is identical to the STA design model. Both
201 assume sheet-flow hydraulics and are calibrated to data primarily from WCA-2A.
202 Vertical mixing within the soil profile is assumed to be minimal. This assumption is
203 supported by substantial vertical and longitudinal gradients in soil P content observed in
204 the WCA-2A soil cores used for calibrating the STADM (Kadlec & Walker, 1999). The
205 accumulation of soil mass in EPGM is driven by a correlation between soil mass
206 accretion rate and soil P accretion rate calibrated to dated soil cores in WCA-2A and
207 tested against limited data from other WCAs. This correlation determines a relationship
208 between the average P content of accreting peat and the average P concentration in the

209 water column (Kadlec & Walker, 1999). EPGM calibration to WCA-2A transect data
210 indicates that soil accretion rates vary from 0.1 to 1.0 kg/m²-yr and the P content of
211 accreting peat varies from 500 to 1400 mg/kg as the average water column P varies from
212 5 to 100 µg L⁻¹.

213

214 EPGM has been applied to evaluate the potential impacts of distributing STA outflows
215 with a P concentration of 50 µg L⁻¹ into previously un-impacted marsh areas along the
216 northern edge of the WCAs (Walker & Kadlec, 1996). Impacts are expressed in terms of
217 marsh areas exceeding water-column and soil P criteria as a function of time as the soil P
218 gradient (Figure 1) develops downstream of the STA outflows. Cattail densities are also
219 predicted based upon an empirical correlation with soil P contents. The development of
220 steady-state soil P profiles requires one or more decades, depending on the inflow
221 concentration, initial soil P content, depth of soil being tracked, and marsh hydroperiod.
222 Once the soil P profile is fully developed, the EPGM calibration to WCA-2A indicates
223 that marsh areas with water-column P concentrations exceeding 10 µg L⁻¹ correspond to
224 areas with steady-state soil P contents exceeding ~650 mg/kg.

225

226 ***Dynamic Model for Stormwater Treatment Areas (DMSTA)***

227

228 DMSTA (Walker & Kadlec, 2001-2005; Kadlec, 2006) was developed to support design
229 of STAs to achieve outflow TP concentrations approaching the 10 µg L⁻¹ criterion.
230 Achieving low P levels requires designing an STA to operate within limited ranges of
231 inflow P concentrations and loads, as well as optimizing vegetation types, water depths,
232 and hydraulics to treat highly pulsed basin runoff. Consideration of these factors requires
233 a dynamic model with an additional P storage compartment to represent labile
234 phosphorus stored in vegetation and litter (Figure 4). This compartment regulates P
235 uptake, recycling, and generation of stable P residuals stored in accreting peat. The
236 initial structure and equations were similar to the autobiotic wetland P model described
237 by Kadlec (1997). Those equations have been refined and calibrated to various emergent

238 and submerged vegetation types (described below) based upon data from South Florida
239 wetlands and treatment areas.

240

241 Whereas the STA design model assumed simple sheet-flow hydraulics downstream of the
242 inflows, DMSTA allows simulation of full STA designs involving multiple treatment
243 cells in series and/or parallel with seepage, bypass constraints based upon water depth or
244 pump capacity, and outlet hydraulic controls (Figure 4). Design optimization generally
245 involves specification of cell areas, configurations, depth regimes, hydraulic features, and
246 target vegetation communities to achieve treatment objectives in a cost-effective manner.
247 The model also has a capability for simulating regional networks of STAs and reservoirs,
248 driven by 35-year daily flow time series generated by SFWMD's regional hydrologic
249 models (SFWMD, 2005). Marsh responses downstream of the STAs can also be
250 simulated using the appropriate calibrations. The spreadsheet interface and limited input
251 data requirements facilitate development and comparison of alternative STA designs.

252

253 The first version of DMSTA (Walker & Kadlec, 2001) was calibrated to data from
254 approximately 70 treatment cells and wetlands ranging in size from 10^{-1} to 10^7 m². Most
255 of the treatment cell datasets were from experimental tanks and small-scale test cells with
256 different vegetation types operated with constant inflows and water depths over periods
257 of one to three years. Data from a treatment wetland (Boney Marsh) and a full-scale test
258 facility (Everglades Nutrient Removal Project, Chimney et al, 2006) provided the
259 primary bases for calibration. Calibrations were developed for periphyton, emergent
260 vegetation, and submerged vegetation based upon data from the largest prototype in each
261 category. A fourth category represented a transition from submerged vegetation to
262 periphyton over a decreasing P gradient. Data from the smaller experimental platforms
263 were used for testing calibrations in each vegetation category. This version of DMSTA
264 was used in initial feasibility studies for enhanced STA designs (Burns and McDonnell,
265 2002; Brown and Caldwell, 2002).

266

267 With operation and intensive monitoring of the STAs by SFWMD, substantially more
268 data from full-scale treatment cells and wetlands with dynamic inflows and water depths

269 were available to support development of the second version of DMSTA (Walker and
270 Kadlec, 2005). This most recent version includes calibrations for four wetland types
271 (emergent, submerged, periphyton, and mixed vegetation on natural wetland soils), as
272 well as a calibration for open-water reservoirs. The reservoir calibration is based upon
273 data from shallow lakes in Florida (Burns & McDonnell, 2004) and developed to support
274 evaluation regional plans involving networks of STAs and storage reservoirs planned for
275 hydrologic restoration purposes (USACE, 2009).

276

277 Steady-state solutions of DMSTA's P cycling equations are mathematically equivalent to
278 the K/C* model (Kadlec, 1994), which is similar to the STA Design Model (Figure 3).
279 Calibrated settling rates are 13-22 m/yr for emergent vegetation, 43-64 m/yr for
280 submerged vegetation, 18-31 $\mu\text{g L}^{-1}$ for periphyton, 27-46 m/yr for mixed vegetation on
281 natural wetland soils, and 3-9 m/yr for reservoirs. The wetland calibrations (first three
282 categories) are in the 60th to 90th percentile range of the global distribution of settling
283 rates, based upon data from 282 treatment wetlands (Kadlec and Wallace (2009). Each
284 calibration is applicable under specific ranges of depth, velocity, and concentration, as
285 determined by the calibration datasets. DMSTA is applicable to treatment cells that have
286 reached a stable operational phase, a process that typically requires one to three years
287 after construction to allow time for the establishment of vegetation and associated P
288 cycles, depending on antecedent soils, water depths, and vegetation.

289

290 The second version of DMSTA has been applied in several feasibility and design studies
291 providing treatment of additional flows and phosphorus loads from the source basins, as
292 well as integration of STAs and storage reservoirs south and north of Lake Okeechobee
293 (Burns and McDonnell. 2002, 2003; ADA, 2005; Brown and Caldwell, 2002,2005,2007;
294 Black and Veatch, 2006; URS Inc, 2005; HDR Inc, 2006; Camp Dresser and McKee,
295 2007; Tetra Tech, 2008). While developed primarily for use in STA design and
296 optimization, DMSTA can also be used as a diagnostic tool to facilitate interpretation of
297 real-time monitoring data from the STAs. Variations in measured STA outflow
298 concentrations reflect variations in inflow volumes, inflow P loads, water depths, climate,
299 management, P cycling within wetland communities, measurement errors, and other

300 random factors. It is difficult to evaluate the inherent P removal performance of the STA
301 wetland community in the context of data variations induced by the other
302 factors. DMSTA factors out the effects of hydrologic variations and STA operations that
303 distribute inflows across cells and regulate water depths. This filtering provides a clearer
304 signal of vegetation function and long-term performance relative to design simulations
305 and management expectations.

306

307 DMSTA's structure assumes that flow through each treatment cell is uniformly
308 distributed across its width (sheet flow). While that assumption is consistent with typical
309 design recommendations, hydraulic inefficiencies (short-circuiting, dead zones) can result
310 from spatial variations in ground elevation and remnant farm canals that were not
311 sufficiently filled or plugged at the time of construction (Guardo and Tomasello 1995;
312 Dierberg et al., 2005; DB Environmental Labs, 2006). To some extent, the effects of
313 these factors are embedded in the DMSTA calibrations and in the tanks-in-series model
314 used to represent each cell (Kadlec and Wallace, 2009). DMSTA incorporates a depth-
315 dependent P uptake function that reflects spatial variations in topography (typically +/- 30
316 cm relative to the mean ground elevation) and the resulting impacts on hydraulic
317 efficiency. To account for extreme variations in topography, the design engineer has the
318 option to adjust the effective treatment area, typically defined as the area flooded at
319 normal operating depth (40 – 60 cm). Future refinements to include explicit
320 consideration of topographic variations within each cell may improve model
321 performance, particularly when water levels are relatively low and risk of short-circuiting
322 is relatively high. While data requirements would limit applicability, the P cycling
323 algorithm can also be superimposed on a full 2-dimensional hydraulic simulation of the
324 STAs, as has been done for WCA-1 (Chen et al., 2009),

325

326 With continued operation and monitoring of the STAs, the database to support further
327 refinement of DMSTA expanded more than three-fold between 2005 and 2009, measured
328 in terms of cell-years. Future versions will provide updated calibrations and additional
329 features useful for design and diagnostic applications.

330

331 Coupled DMSTA and EPGM

332

333 A fourth model under development links DMSTA and EPGM to simulate three
334 aggregated P storage compartments (water column, vegetation, and soil, Figure 3). In the
335 initial version, the structures and calibrations of the DMSTA and EPGM components are
336 unchanged. The soil P compartment is driven by the predicted net accretion from the
337 vegetation P storage compartment of DMSTA. The accretion rates are time-variable, as
338 compared with the original EPGM driven by the steady-state water column concentration
339 profile generated by the STADM.

340

341 The long-term decreasing trends in WCA inflow and outflow concentrations (Figure 2)
342 suggest that water column P concentrations respond relatively rapidly to reductions in
343 inflow P, despite the substantial amounts of P stored in the soils of impacted marsh
344 areas, release of which would delay the water column response. DMSTA testing results
345 also indicate that explicit simulation of the soil P compartment may not be necessary for
346 predicting water-column P variations in the natural marsh or in treatment cell outflows in
347 response to trends in the inflow volumes or concentrations once STA vegetation
348 (DMSTA P storage pool) is stabilized. Effects of soil P storage and exchanges with the
349 water column and vegetation are currently embedded in DMSTA calibrations. Further
350 testing against data in lower P ranges will be possible as STA performance improves and
351 the natural marsh responds to decreasing P loads. Despite greater uncertainty and data
352 limitations, explicit consideration of soil P may improve water-column P simulations in
353 dry periods, which the effects of soil P reflux would be greatest (Pant and Reddy, 2003).
354 While less important for STA design, explicit simulation of soil P levels may be useful
355 for forecasting the spatial and temporal scales associated with restoration of rooted
356 vegetation and other ecosystem components that respond more to soil P variations than to
357 water column P variations.

358

359 The existing calibrations of DMSTA and EPGM provide a basis for estimating the time
360 scales required for P stored in each compartment to equilibrate following a change in the
361 long-term average water column P concentration (Figure 5). These scales depend upon

362 the ratio of stored phosphorus to the average input P flux to each compartment computed
363 from a steady-state solution of the P cycling model. Starting from a given set of initial
364 conditions, time scales are expressed as the number of years required for 90% of the shift
365 to new equilibrium distribution of stored P. Equilibration of storage compartments to an
366 ambient P concentration of $10 \mu\text{g L}^{-1}$ involves time scales ranging from ~1 to 3 years for
367 the vegetation P storage compartment, ~10 years for the 0-2 cm soil horizon, and ~50
368 years for the 0-10 cm soil horizon. Response times are shorter at higher P concentrations
369 because of increases in the P cycling and soil accretion rates.

370

371 The temporal and spatial scales of marsh response to increasing or decreasing P loads are
372 further illustrated in Figure 6. The preliminary model has been applied to simulate
373 variations in P concentration and storage along the WCA-2A marsh transect in response
374 to variations in inflow volume and P load over a 100 year period. The 1963-1995 period
375 represents historical conditions when the marsh P gradient developed in response to
376 increases in P load starting 1960's. P loads gradually decreased between 1995 and 2007
377 period with implementation of upstream P controls and flow diversions. A hypothetical
378 reduction of inflow concentration to a long-term flow-weighted mean of $12 \mu\text{g L}^{-1}$
379 (approximately equivalent to a geometric mean of $10 \mu\text{g L}^{-1}$) is imposed in 2008-2062
380 simulation period. Year-to-year variations in inflow volume and concentration around 12
381 $\mu\text{g L}^{-1}$ have been estimated from variations in the historical time series. Soil P content in
382 1963 is initialized at 350 mg/kg based upon vertical soil P profiles in WCA-2A. Marsh
383 response is expressed as areas exceeding various water column P and soil P criteria in
384 each compartment. Areas are computed from the simulated distance along the transect
385 and an average transect width of 10.5 km (Walker, 1995). As expected based upon the
386 steady-state analysis (Figure 5), labile P storage in vegetation responds within a few years
387 to the reduction in inflow concentration, whereas the soil compartments respond over
388 several decades.

389

390 Processes not directly reflected in the existing model, such as soil P recycling induced by
391 peat oxidation or mining of soil phosphorus by rooted vegetation, may decrease response
392 times for P stored in the soil but increase the time scales for P stored in the vegetation and

393 water column. One limitation of the EPGM component is that it was calibrated to soils
394 cores collected in 1990-1991 and reflected marsh response to an increase in P load over
395 the 1963-1990 period, when inflow P loads were generally increasing. Substantial data
396 collected since then provide a basis for refining the structure and calibration in the
397 coupled EPGM/DMSTA model. Recent data also provide a basis for testing the model
398 in a recovery mode as the WCA2A marsh responds to further decreases in inflow P load.
399 Data from soil and water column transects in other WCAs are also available to support
400 further refinements (SFWMD, 2009b).

401 **Future Applications to Everglades Restoration**

402

403 Restoring the Everglades will require delivery of water with sufficient volume, timing,
404 and quality to achieve hydrologic and water quality objectives. Implementation of
405 hydrologic restoration measures will alter the quantities and timing of marsh inflows
406 (USACE, 2009). Changes in timing could have positive or negative impacts on STA
407 performance, depending on how they affect peak inflow volumes and P loads. DMSTA
408 can play continued roles in engineering solutions to achieve both hydrologic and water
409 quality goals. These solutions are likely to involve combinations of the following
410 measures:

411

- 412 1. Additional BMPs to further reduce runoff P concentrations
- 413 2. Diversions to balance flows and P loads across STAs
- 414 3. Integration of reservoirs to attenuate peak inflows to the STAs
- 415 4. Further optimization of the hydraulics, vegetation, and operation of existing STAs
- 416 5. Additional STA expansion

417

418 Further refinement of the modeling tools will be possible with continued research and
419 monitoring conducted under Florida's Long-Term Plan (B&M, 2003; SFWMD, 2009b).

420

421

422 **References**

423

424 ADA Engineering, Inc., 2005. EAA Regional Feasibility Study, prepared for South
425 Florida Water Management District.

426

427 Black & Veatch, Inc., 2006. EAA Reservoir A-1 Basis of Design Report, prepared for
428 South Florida Water Management District.

429

430 Brown and Caldwell, Inc., 2002. Basin Specific Feasibility Studies, Everglades
431 Stormwater Program Basins, prepared for South Florida Water Management District.

432

433 Brown and Caldwell, Inc., 2005. STA-2 Cell 4 Final Basis for Design, prepared for
434 South Florida Water Management District.

435

436 Brown and Caldwell, Inc., 2007. Basis of Design Report, Compartment B Build-Out,
437 prepared for South Florida Water Management District.

438

439 Burns and McDonnell, 1994, Everglades Protection Project Conceptual Design, prepared
440 for South Florida Water Management District.

441

442 Burns and McDonnell, 1999. Stormwater Treatment Area No. 3/4 Alternatives Analysis,
443 Prepared for South Florida Water Management District.

444

445 Burns and McDonnell, 2002, Basin-Specific Feasibility Studies, Everglades Protection
446 Area Tributary Basins, Evaluation of Alternatives for the ECP Basins, prepared for South
447 Florida Water Management District.

448

449 Burns and McDonnell, 2003. Everglades Protection Area Tributary Basins Long-Term
450 Plan for Achieving Water Quality Goals, prepared for South Florida Water Management

451 District. <http://www.sfwmd.gov/sta>

452

453 Burns and McDonnell, 2004, Water Quality Impacts of Reservoirs, prepared for South
454 Florida Water Management District.

455

456 Camp, Dresser, McKee, Inc., 2007. LOFT Basis of Design Report, Taylor Creek,
457 Nubbin Slough, Brady Ranch, and Lakeside Ranch Stormwater Treatment Areas,
458 prepared for South Florida Water Management District.

459

460 Chen, C., Meselhe, E. A., Waldon, M. G, 2009. A.R.M. Loxahatchee National Wildlife
461 Refuge Hydrodynamic Modeling with MIKE FLOOD, prepared for U.S. Fish and
462 Wildlife Service.

463

464 Chimney, M.J., Goforth, G., 2006. History and description of the Everglades Nutrient
465 Removal Project, a subtropical constructed wetland in south Florida,. *Ecological*
466 *Engineering* 27 (4): 268-278.

467

468 Cohen, M.J., T.Z. Osborne, S. Lamsal, M.W. Clark, “Regional Distribution of Soil
469 Nutrients – Hierarchical Soil Nutrient Mapping for Improved Ecosystem Change
470 Detection”, prepared for U.S. Army Corps of Engineers, University of Florida Soil and
471 Water Science Department.

472

473 Craft, B.B. and C.J. Richardson, 1993a. Peat Accretion and N, P and Organic C
474 Accumulation in Nutrient-Enriched and Unenriched Everglades Peatlands. *Ecological*
475 *Applications*. 3(3):446-458.

476

477 Craft, B.B. and C.J. Richardson, 1993b. Peat Accretion and Phosphorus Accumulation
478 Along a Eutrophication Gradient in the Northern Everglades. *Biogeochemistry* 22: 13-
479 156.

480

481 DB Environmental, Inc., 2005. Baseline tracer study: STA-2, Cell 3. Final Report
482 submitted to South Florida Water Management District, West Palm Beach, FL.

483 Dierberg, F.E., DeBusk, T.A., Jackson, S.D., Chimney, M.J., Pietro, K., 2002.
484 Submerged aquatic vegetation-based treatment wetlands for removing phosphorus from
485 agricultural runoff: response to hydraulic and nutrient loading. *Water Res.* 36, 1409–422.
486

487 Fitz, H.C. and B. Trimble, 2006. Documentation of the Everglades Landscape Model:
488 ELM v2.5. Report from SFWMD, West Palm Beach, FL. <https://my.sfwmd.gov/elm>
489

490 Grunwald, S., K. R. Reddy, S. Newman, and W. F. DeBusk, 2004. Spatial variability,
491 distribution and uncertainty assessment of soil phosphorus in a south Florida wetland.
492 *Envirometrics*, 15: 811–825.
493

494 Guardo, M., Tomasello, R.S., 1995. Hydrodynamic simulations of a constructed wetland
495 in south Florida. *Water Resour. Bull.* 31, 687–701.
496

497 HDR, Inc., 2006. C44 Reservoir/STA Final Basis for Design, prepared for U.S. Army
498 Corps of Engineers and South Florida Water Management District.
499

500 HydroQual, Inc., 1998. SFWMD Wetlands Model: Calibration of the Coupled
501 Periphyton/Vegetation Model to the ENR. Report to SFWMD, Project SFWD0105,
502 March 1998, West Palm Beach, FL.
503

504 Jawitz, J.W., R. Muñoz-Carpena, S. Muller, K.A. Grace, A.I. James, 2008. Development,
505 Testing, and Sensitivity and Uncertainty Analyses of a Transport and Reaction
506 Simulation Engine (TaRSE) for Spatially Distributed Modeling of Phosphorus in the Peat
507 Marsh Wetlands of Southern Florida, U.S. Department of the Interior, Geological Survey,
508 Scientific Investigation Report 2008-5029.
509

510 Kadlec, R. H., 1994. Phosphorus Uptake in Florida Marshes, *Water Science and*
511 *Technology*, 30 (8): 225-234.
512

- 513 Kadlec, R. H., 1997. An Autobiotic Wetland Phosphorus Model, Ecol. Eng. 8 (2): 145-
514 172.
515
- 516 Kadlec, R.H., Walker, W.W., 1999. Management Models to Evaluate Phosphorus
517 Impacts in Wetlands, Chapter 27 in: Phosphorus Biogeochemistry in Subtropical
518 Ecosystems, K.R. Reddy, G.A. O'Connor and C.L. Schelske, eds., Lewis Publishers,
519 Boca Raton, FL, 621-642.
520
- 521 Kadlec, R.H., 2006. Free Surface Wetlands for Phosphorus Removal: the position of the
522 Everglades Nutrient Removal Project, Ecological Engineering 27: 361-379.
523
- 524 Kadlec, R. H. and S.D. Wallace, 2009. Treatment Wetlands, Second Edition, CRC Press,
525 Boca Raton, FL, 1016 pp.
526
- 527 Moustafa, M.Z. and J.M. Hamrick, 2000. Calibration of the Wetland Hydrodynamic
528 Model to the Everglades Nutrient Removal Project, Water Quality and Ecosystem
529 Modeling. 1:141-167.
530
- 531 Munson, R.K., S.B. Roy, S.A. Gherini, A.L. MacNeill, R.J.M. Hudson, and V.L. Blette,
532 2002. Model Prediction of the Effects of Changing Phosphorus Loads on the Everglades
533 Protection Area, Water, Air and Soil Pollution, 134: 255-273.
534
- 535 Pant, H.K., Reddy, K.R., 2003. Potential internal loading of phosphorus in a wetland
536 constructed in agricultural land. Water Res. 37, 965-972.
537
- 538 Payne, G., K. Weaver and T. Bennett, 2003. Development of a Numeric P Criterion for
539 the Everglades Protection Area, Chapter 5, 2003 Everglades Consolidated Report, South
540 Florida Water Management District.
541
- 542 Payne, G., K. Weaver, and F. Nearhoof, 2008. " Technical Support Document:
543 Derivation of the Water Quality Based Effluent Limit (WQBEL) for Phosphorus in

544 Discharges to the Everglades Protection Area”, Florida Department of Environmental
545 Protection, Bureau of Standards and Special Projects.
546

547 Reddy, K.R., W. F. Debusk, Y. Wang, R.D. De Luane, and M.S. Koch, 1991. Physico-
548 Chemical Properties of Soils in the Water Conservation Area 2 of the Everglades.
549 Report to South Florida Water Management District, West Palm Beach, Florida.
550

551 Reddy, K.R., R.D. De Luane, W.F. DeBusk, and M.S. Koch, 1993. Long-Term Nutrient
552 Accumulation Rates in the Everglades. *Soil. Sci. Soc. Am. J.* 57: 1147-1159.
553

554 South Florida Water Management District, 2005. Documentation of the South Florida
555 Water Management Model, Version 5.5.
556

557 South Florida Water Management District, 2009a. DBHYDRO Hydrologic and Water
558 Quality Database. <http://www.sfwmd.gov>
559

560 South Florida Water Management District, 2009b. South Florida Environmental Report.
561 <http://www.sfwmd.gov>
562

563 Tetra Tech, Inc., 2008. “Environmental Impact Statement To Construct Stormwater
564 Treatment Areas on Compartments B and C of the Everglades Agricultural Area,
565 Florida”, prepared for U.S. Army Corps of Engineers, Jacksonville District.
566

567 URS, Inc. 2005. Basis of Design Report, Stormwater Treatment Area 6 Section 2 and
568 Modifications to Section 1, prepared for South Florida Water Management District.
569

570 U.S. Army Corps of Engineers, 2009. Comprehensive Everglades Restoration Plan
571 (CERP). <http://www.evergladesplan.org>
572

573 Walker, W. W., 1995. Design basis for Everglades stormwater treatment areas, Water
574 Resources Bulletin, 31 (4): 671-685.

575

576 Walker, W.W., Kadlec, R.H., 1996. A Model for Simulating Phosphorus Concentrations
577 in Waters and Soils Downstream of Everglades Stormwater Treatment Areas, prepared
578 for U.S. Department of Interior. <http://www.wwwalker.net/epgm>

579

580 Walker, W.W., Kadlec, R.H., 2001. Dynamic Model for Stormwater Treatment Areas,
581 Model Version 1.

582

583 Walker, W.W., Kadlec, R.H., 2005. Dynamic Model for Stormwater Treatment Areas,
584 Model Version 2. <http://www.wwwalker.net/dmsta>

585

586

587 **Acknowledgement**

588

589 This work was supported primarily by the U.S. Department of the Interior. The findings
590 and conclusions in this article are those of the authors and do not necessarily represent
591 the views of the supporting agency. Supporting data were provided primarily by South
592 Florida Water Management District.

593

594

Walker & Kadlec, GEER 2008 Figures

- Figure 1 Phosphorus Gradient in Wetland Vegetation, Water, and Soils under Historical and Restored Conditions
- Figure 2 Long-Term Trends in the Everglades Regional Phosphorus Gradient
- Figure 3 Evolution of Phosphorus Mass Balance Models with Increasing Complexity
- Figure 4 Components of DMSTA
- Figure 5 Time Scales of Phosphorus Storage in Marsh Soils and Vegetation
- Figure 6 Simulation of WCA-2A Response to Reductions in Inflow P Concentration

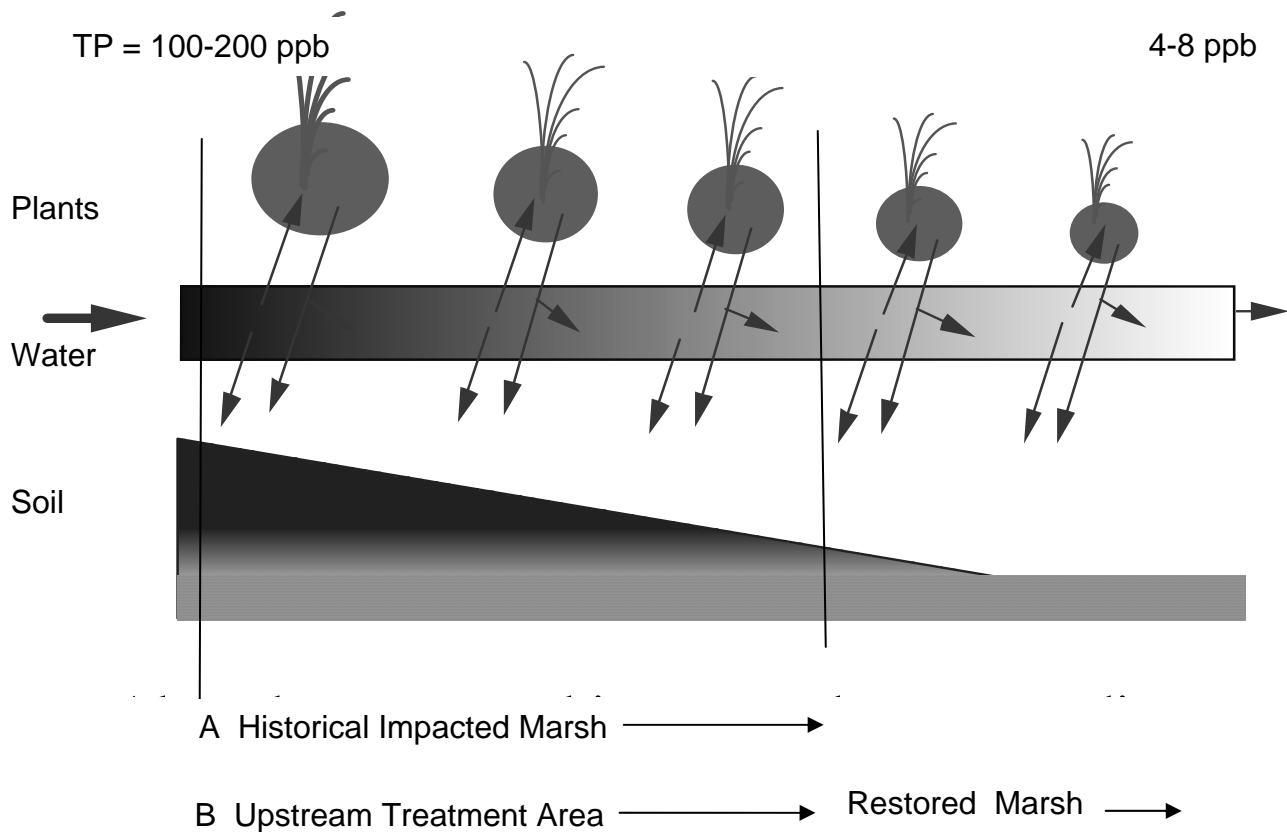

Figure 1

Phosphorus Gradient in Wetland Vegetation, Water Column, and Soils under Historical and Restored Conditions.

A - Historical conditions (before implementation of phosphorus controls). The P gradient is located entirely with the impacted natural marsh.

B - Future restored conditions (after full implementation of P controls). Most of the P gradient is moved upstream out of the natural marsh and located with wetland stormwater treatment areas constructed on adjacent agricultural lands. The remaining gradient within the marsh extends from 10 ppb in the treatment area outflows to marsh background levels.

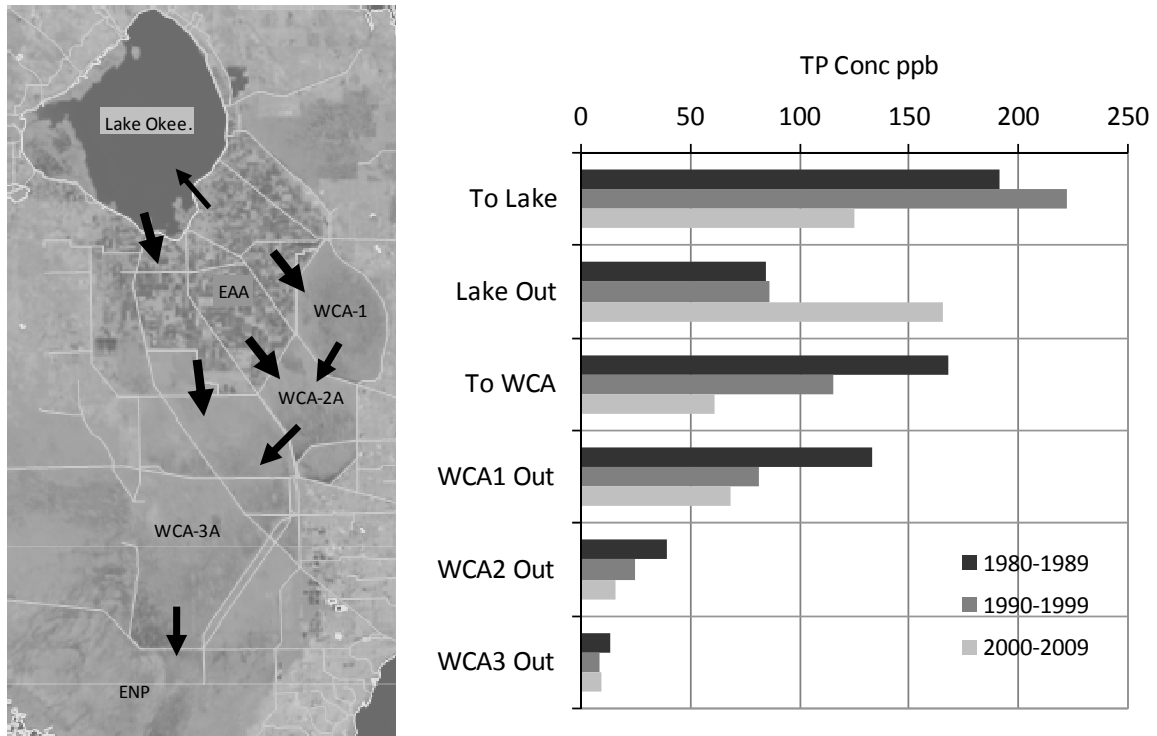

Figure 2

Long-Term Trends in the Everglades Regional Phosphorus Gradient

Phosphorus concentrations are flow-weighted means. Flow and concentration data are from DBHYDRO (SFWMD, 2009a)

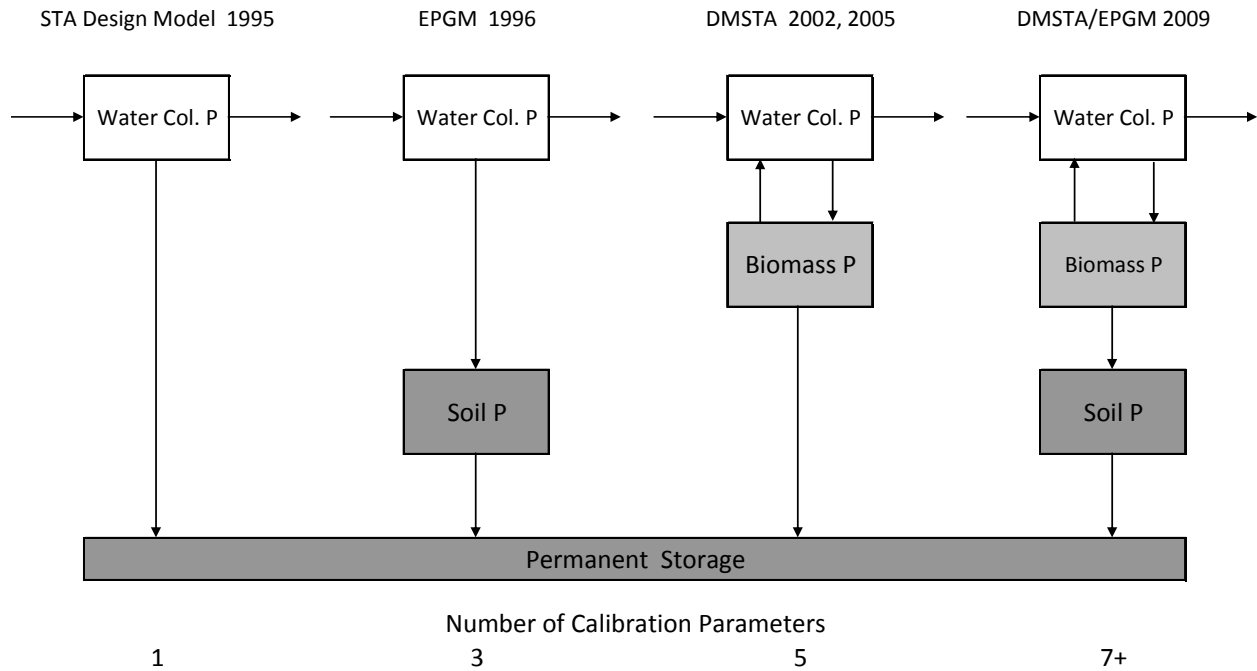
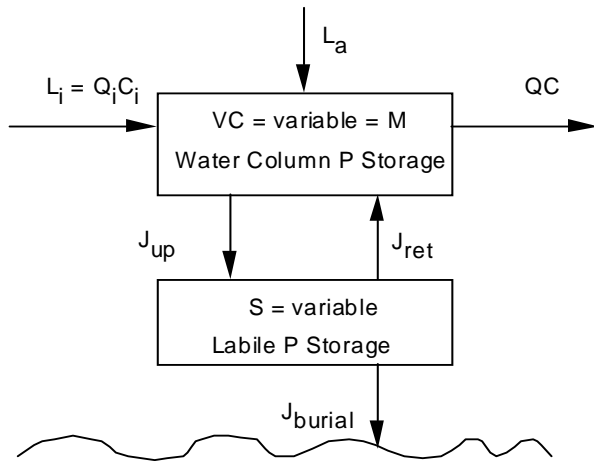

Figure 3

Evolution of Phosphorus Mass Balance Models with Increasing Complexity

Aggregated P compartments and net fluxes are shown for four mass balance models developed over the 1995-2009 period. Permanent storage represents burial of stable P forms in accreting peat. The number of calibrated parameters increases with model complexity.

A - P Cycling Model



B - Hydraulic Routing Model for One Cell

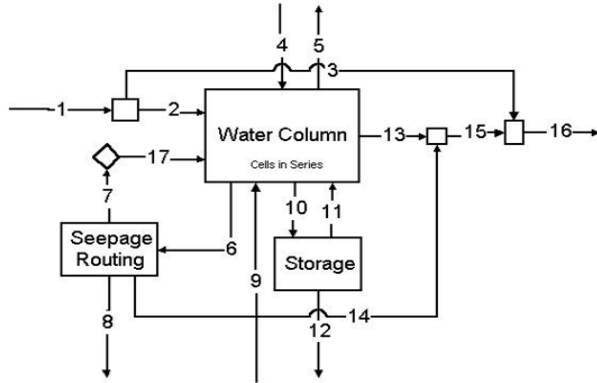

C - Cell Network Configurations

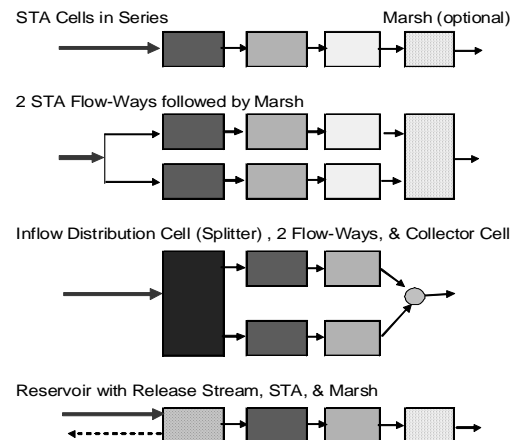

D - User Interface

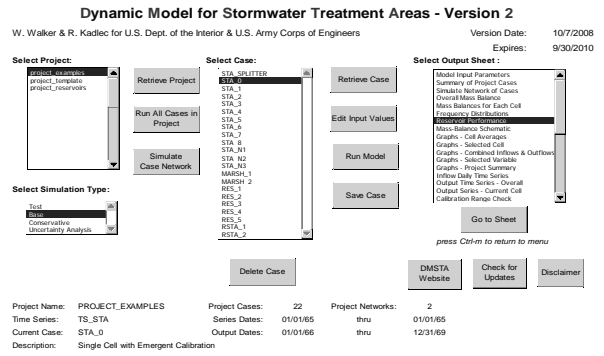

Figure 4

Components of DMSTA

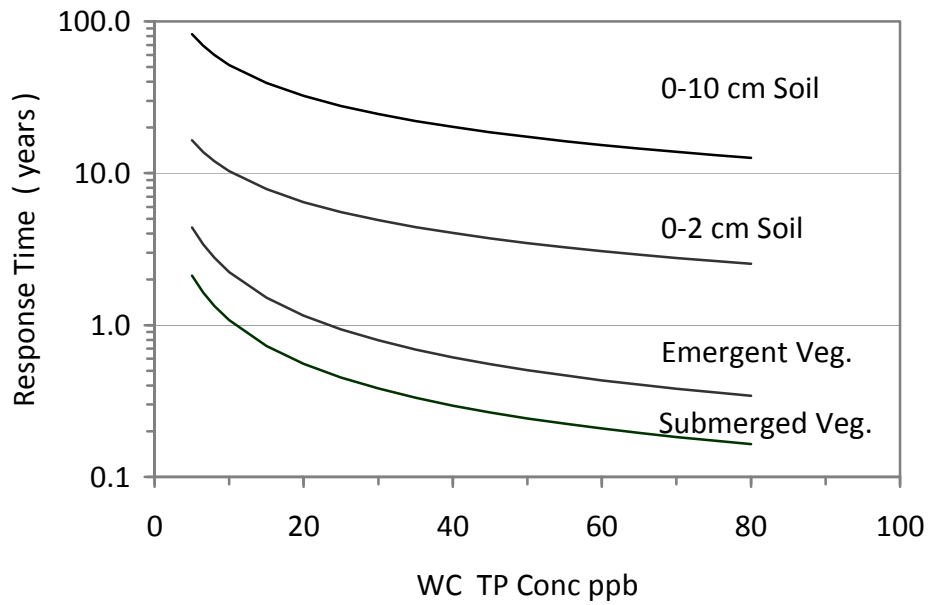

Figure 5

Time Scales of Phosphorus Storage in Wetland Soils and Vegetation

Represent approximate time required for P storage compartments to adjust to a change in the long-term average water-column P concentration. Computed from EPGM and DMSTA calibrations.

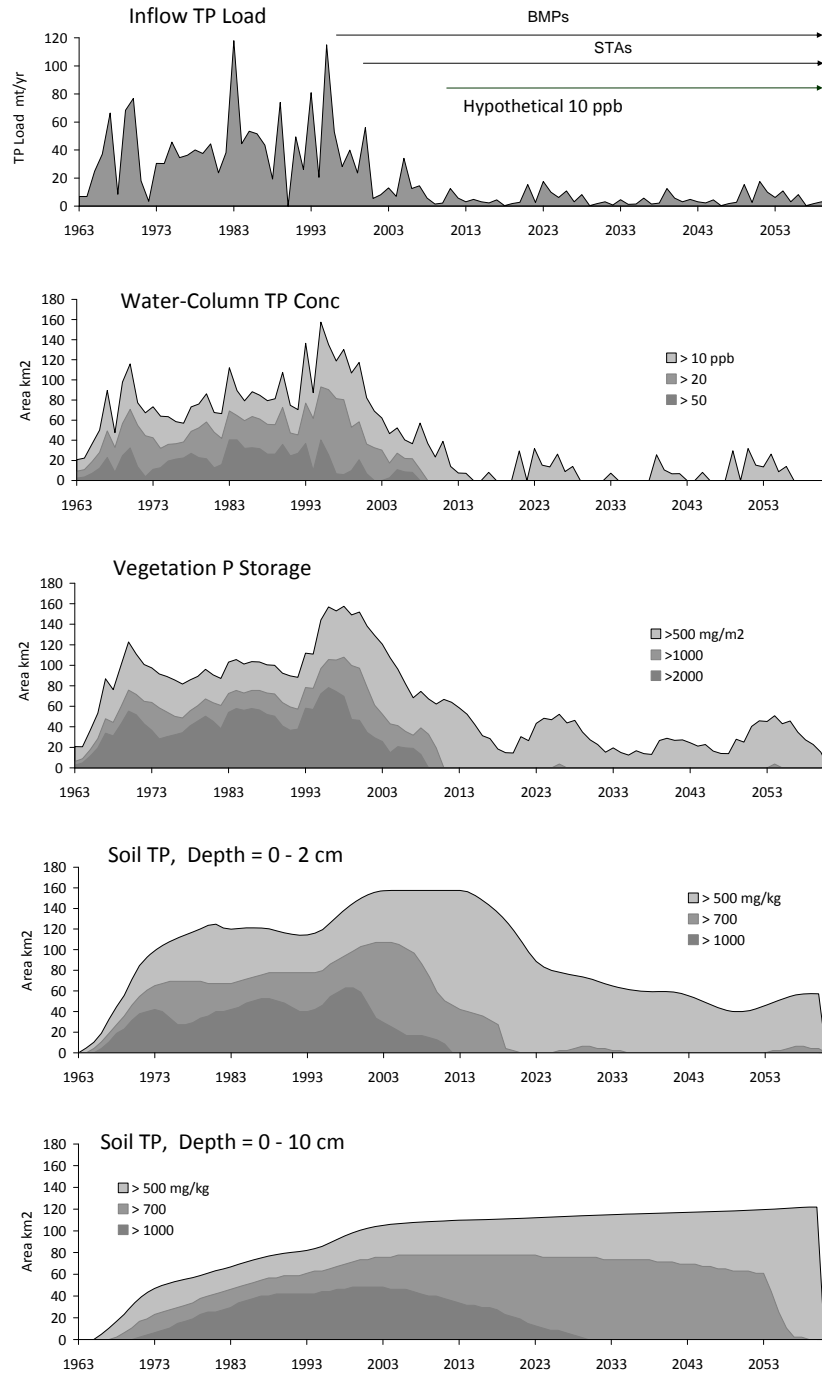

Figure 6

Simulation of WCA-2A Response to Reductions in Inflow P Concentration using the Coupled EPGM/DMSTA Models